

The image features a blue background with a faint world map. In the top right corner, the AVX logo is displayed in white, with the text "A KYOCERA GROUP COMPANY" underneath. The central part of the image is a collage of three tilted panels. The top panel shows several small, rectangular surface-mount capacitors against a yellow and orange background. The middle panel shows four larger, rectangular surface-mount capacitors on a silver, textured surface. The bottom panel shows four rectangular capacitors of various sizes on a purple background, with a green printed circuit board (PCB) visible in the background.

**AVX**  
A KYOCERA GROUP COMPANY

AVX  
Surface Mount  
Ceramic Capacitor Products

# Ceramic Chip Capacitors



## Table of Contents

<b>How to Order - AVX Part Number Explanation</b> .....	<b>2-3</b>
<b>C0G (NP0) Dielectric</b>	
General Specifications .....	<b>4</b>
Specifications and Test Methods .....	<b>5</b>
Capacitance Range .....	<b>6-7</b>
<b>U Dielectric</b>	
General Information .....	<b>8</b>
Capacitance Range .....	<b>9-10</b>
Designer Kits .....	<b>11</b>
<b>X7R Dielectric</b>	
General Specifications .....	<b>12</b>
Specifications and Test Methods .....	<b>13</b>
Capacitance Range .....	<b>14-15</b>
<b>X7S Dielectric</b>	
General Specifications .....	<b>16</b>
Specifications and Test Methods .....	<b>17</b>
Capacitance Range .....	<b>18</b>
<b>X5R Dielectric</b>	
General Specifications .....	<b>19</b>
Specifications and Test Methods .....	<b>20</b>
Capacitance Range .....	<b>21-22</b>
<b>Y5V Dielectric</b>	
General Specifications .....	<b>23</b>
Specifications and Test Methods .....	<b>24</b>
Capacitance Range .....	<b>25</b>
<b>MLCC Tin/Lead Termination</b>	
General Specifications .....	<b>26</b>
Capacitance Range .....	<b>27-31</b>
<b>Automotive MLCC</b>	
General Specifications .....	<b>32-33</b>
Capacitance Range .....	<b>34-35</b>
<b>MLCC with Soft Termination</b>	
General Description .....	<b>36</b>
Specifications and Test Methods .....	<b>37-38</b>
Capacitance Range .....	<b>39</b>
<b>Capacitor Array</b>	
General Description .....	<b>40</b>
Capacitance Range .....	<b>41</b>
Multi-Value Capacitor Array (IPC) .....	<b>42</b>
Part and Pad Layout Dimensions .....	<b>43</b>
<b>Low Inductance Capacitors</b>	
Introduction .....	<b>44-45</b>
LICC (Low Inductance Chip Capacitors) .....	<b>46-47</b>
IDC (InterDigitated Capacitors) .....	<b>48-49</b>
LICA (Low Inductance Decoupling Capacitor Arrays) .....	<b>50-51</b>
<b>High Voltage Chips for 600V to 5000V Applications</b> .....	<b>52-53</b>
<b>MIL-PRF-55681/Chips</b>	
Part Number Example (CDR01 thru CDR06) .....	<b>54</b>
Military Part Number Identification (CDR01 thru CDR06) .....	<b>55</b>
Part Number Example (CDR31 thru CDR35) .....	<b>56</b>
Military Part Number Identification (CDR31) .....	<b>57</b>
Military Part Number Identification (CDR32) .....	<b>58</b>
Military Part Number Identification (CDR33/34/35) .....	<b>59</b>
<b>Packaging of Chip Components</b> .....	<b>60</b>
<b>Embossed Carrier Configuration - 8 &amp; 12mm Tape</b> .....	<b>61</b>
<b>Paper Carrier Configuration - 8 &amp; 12mm Tape</b> .....	<b>62</b>
<b>Bulk Case Packaging</b> .....	<b>63</b>
<b>Basic Capacitor Formulas</b> .....	<b>64</b>
<b>General Description</b> .....	<b>65-69</b>
<b>Surface Mounting Guide</b> .....	<b>70-73</b>

# How to Order

## Part Number Explanation

### Commercial Surface Mount Chips

#### EXAMPLE: 08055A101JAT2A

0805	5	A	101	J*	A	T	2	A
<b>Size</b> (L" x W")	<b>Voltage</b>	<b>Dielectric</b>	<b>Capacitance</b>	<b>Tolerance</b>	<b>Failure Rate</b>	<b>Terminations</b>	<b>Packaging</b>	<b>Special Code</b>
0201 0402 0603 0805 1206 1210 1812 1825 2220 2225	4 = 4V 6 = 6.3V Z = 10V Y = 16V 3 = 25V D = 35V 5 = 50V 1 = 100V 2 = 200V 7 = 500V	A = NP0(C0G) C = X7R D = X5R G = Y5V U = U Series W = X6S Z = X7S	2 Sig. Fig + No. of Zeros Examples: 100 = 10 pF 101 = 100 pF 102 = 1000 pF 223 = 22000 pF 224 = 220000 pF 105 = 1µF 106 = 10µF 107 = 100µF For values below 10 pF, use "R" in place of Decimal point, e.g., 9.1 pF = 9R1.	B = ±.10 pF C = ±.25 pF D = ±.50 pF F = ±1% (≥ 10 pF) G = ±2% (≥ 10 pF) J = ±5% K = ±10% M = ±20% Z = +80%, -20% P = +100%, -0%	A = N/A 4 = Automotive	T = Plated Ni and Sn 7 = Gold Plated J = Tin/Lead	<u>Available</u> 2 = 7" Reel 4 = 13" Reel 7 = Bulk Cass. 9 = Bulk	A = Std.
		<b>Contact Factory for Special Voltages</b> F = 63V    9 = 300V * = 75V    X = 350V E = 150V    8 = 400V V = 250V				<b>Contact Factory For</b> <b>1 = Pd/Ag Term</b> <b>Z = Soft Termination</b>	<b>Contact Factory For</b> <b>Multiples</b>	
						* B, C & D tolerance for ≤10 pF values. Standard Tape and Reel material (Paper/Embossed) depends upon chip size and thickness. See individual part tables for tape material type for each capacitance value.		

### High Voltage Surface Mount Chips

#### EXAMPLE: 1808AA271KA11A

1808	A	A	271	K	A	1	1A
<b>AVX Style</b>	<b>Voltage</b>	<b>Temperature Coefficient</b>	<b>Capacitance Code</b>	<b>Capacitance Tolerance</b>	<b>Failure Rate</b>	<b>Termination</b>	<b>Packaging/Marking</b>
1206 1210 1808 1812 1825 2220 2225 3640	C = 600V A = 1000V S = 1500V G = 2000V W = 2500V H = 3000V J = 4000V K = 5000V	A = C0G C = X7R	(2 significant digits + no. of zeros) Examples: 10 pF = 100 100 pF = 101 1,000 pF = 102 22,000 pF = 223 220,000 pF = 224 1 µF = 105	C0G: J = ±5% K = ±10% M = ±20% X7R: K = ±10% M = ±20% Z = +80%, -20%	A=Not Applicable	1 = Pd/Ag T = Plated Ni and Sn	1A = 7" Reel Unmarked 3A = 13" Reel Unmarked 9A = Bulk/Unmarked

# How to Order

## Part Number Explanation



### Capacitor Array

#### EXAMPLE: W2A43C103MAT2A

<b>W</b>	<b>2</b>	<b>A</b>	<b>4</b>	<b>3</b>	<b>C</b>	<b>103</b>	<b>M</b>	<b>A</b>	<b>T</b>	<b>2A</b>
<b>Style</b>	<b>Case Size</b>	<b>Array</b>	<b>Number of Caps</b>	<b>Voltage</b>	<b>Dielectric</b>	<b>Capacitance Code (In pF)</b>	<b>Capacitance Tolerance</b>	<b>Failure Rate</b>	<b>Termination Code</b>	<b>Packaging &amp; Quantity Code</b>
	1 = 0405 2 = 0508 3 = 0612			6 = 6.3V Z = 10V Y = 16V 3 = 25V 5 = 50V 1 = 100V	A = NP0 C = X7R D = X5R	2 Sig Digits + Number of Zeros	J = ±5% K = ±10% M = ±20%		T = Plated Ni and Sn	2A = 7" Reel (4000) 4A = 13" Reel (10000) 2F = 7" Reel (1000)

### Low Inductance Capacitors (LICC)

#### EXAMPLE: 0612ZD105MAT2A

<b>0612</b>	<b>Z</b>	<b>D</b>	<b>105</b>	<b>M</b>	<b>A</b>	<b>T</b>	<b>2</b>	<b>A</b>
<b>Size</b>	<b>Voltage</b>	<b>Dielectric</b>	<b>Capacitance Code (In pF)</b>	<b>Capacitance Tolerance</b>	<b>Failure Rate</b>	<b>Terminations</b>	<b>Packaging Available</b>	<b>Thickness</b>
0306 0508 0612	6 = 6.3V Z = 10V Y = 16V 3 = 25V 5 = 50V	C = X7R D = X5R	2 Sig. Digits + Number of Zeros	K = ±10% M = ±20%	A = N/A	T = Plated Ni and Sn J = Tin/Lead	2 = 7" Reel 4 = 13" Reel	See Page 51 for Codes

### Interdigitated Capacitors (IDC)

#### EXAMPLE: W3L16D225MAT3A

<b>W</b>	<b>3</b>	<b>L</b>	<b>1</b>	<b>6</b>	<b>D</b>	<b>225</b>	<b>M</b>	<b>A</b>	<b>T</b>	<b>3</b>	<b>A</b>
<b>Style</b>	<b>Case Size</b>	<b>Low Inductance</b>	<b>Number of Terminals</b>	<b>Voltage</b>	<b>Dielectric</b>	<b>Capacitance Code (In pF)</b>	<b>Capacitance Tolerance</b>	<b>Failure Rate</b>	<b>Termination</b>	<b>Packaging Available</b>	<b>Thickness</b>
	2 = 0508 3 = 0612		1 = 8 Terminals	4 = 4V 6 = 6.3V Z = 10V Y = 16V	C = X7R D = X5R	2 Sig. Digits + Number of Zeros	M = ±20%	A = N/A	T = Plated Ni and Sn	1 = 7" Reel 3 = 13" Reel	<u>Max. Thickness</u> mm (in.) A=0.95 (0.037) S=0.55 (0.022)

### Decoupling Capacitor Arrays (LICA)

#### EXAMPLE: LICA3T183M3FC4AA

<b>LICA</b>	<b>3</b>	<b>T</b>	<b>183</b>	<b>M</b>	<b>3</b>	<b>F</b>	<b>C</b>	<b>4</b>	<b>A</b>	<b>A</b>
<b>Style &amp; Size</b>	<b>Voltage</b>	<b>Dielectric</b>	<b>Cap/Section (EIA Code)</b>	<b>Capacitance Tolerance</b>	<b>Height Code</b>	<b>Termination</b>	<b>Reel Packaging</b>	<b># of Caps/Part</b>	<b>Inspection Code</b>	<b>Code Face</b>
	5V = 9 10V = Z 25V = 3	D = X5R T = T55T S = High K T55T		M = ±20% P = GMV	6 = 0.500mm 3 = 0.650mm 1 = 0.875mm 5 = 1.100mm 7 = 1.600mm	F = C4 Solder Balls- 97Pb/3Sn H = C4 Solder Balls-Low ESR P = Cr-Cu-Au N = Cr-Ni-Au X = None	M = 7" Reel R = 13" Reel 6 = 2"x2" Waffle Pack 8 = 2"x2" Black Waffle Pack 7 = 2"x2" Waffle Pack w/ termination facing up A = 2"x2" Black Waffle Pack w/ termination facing up C = 4"x4" Waffle Pack w/ clear lid	1 = one 2 = two 4 = four	A = Standard Reliability Testing B = Established Reliability Testing	A = Bar B = No Bar C = Dot, S55S Dielectrics



# C0G (NP0) Dielectric



## General Specifications

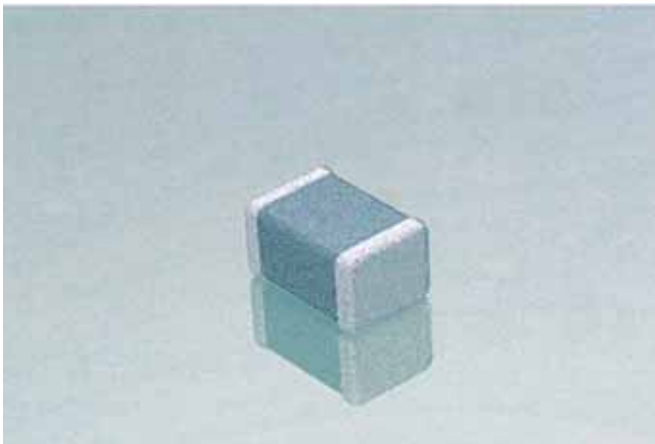

C0G (NP0) is the most popular formulation of the “temperature-compensating,” EIA Class I ceramic materials. Modern C0G (NP0) formulations contain neodymium, samarium and other rare earth oxides.

C0G (NP0) ceramics offer one of the most stable capacitor dielectrics available. Capacitance change with temperature is  $0 \pm 30 \text{ ppm}/^\circ\text{C}$  which is less than  $\pm 0.3\% \Delta C$  from  $-55^\circ\text{C}$  to  $+125^\circ\text{C}$ . Capacitance drift or hysteresis for C0G (NP0) ceramics is negligible at less than  $\pm 0.05\%$  versus up to  $\pm 2\%$  for films. Typical capacitance change with life is less than  $\pm 0.1\%$  for C0G (NP0), one-fifth that shown by most other dielectrics. C0G (NP0) formulations show no aging characteristics.

The C0G (NP0) formulation usually has a “Q” in excess of 1000 and shows little capacitance or “Q” changes with frequency. Their dielectric absorption is typically less than 0.6% which is similar to mica and most films.

## PART NUMBER (see page 2 for complete part number explanation)

**0805**

**Size**  
(L" x W")

**5**

**Voltage**  
6.3V = 6  
10V = Z  
16V = Y  
25V = 3  
50V = 5  
100V = 1  
200V = 2  
500V = 7

**A**

**Dielectric**  
C0G (NP0) = A

**101**

**Capacitance Code (In pF)**  
2 Sig. Digits + Number of Zeros

**J**

**Capacitance Tolerance**  
B =  $\pm 10 \text{ pF}$  ( $< 10 \text{ pF}$ )  
C =  $\pm 25 \text{ pF}$  ( $< 10 \text{ pF}$ )  
D =  $\pm 50 \text{ pF}$  ( $< 10 \text{ pF}$ )  
F =  $\pm 1\%$  ( $\geq 10 \text{ pF}$ )  
G =  $\pm 2\%$  ( $\geq 10 \text{ pF}$ )  
J =  $\pm 5\%$   
K =  $\pm 10\%$

**A**

**Failure Rate**  
A = Not Applicable

**T**

**Terminations**  
T = Plated Ni and Sn  
7 = Gold Plated

**2**

**Packaging**  
2 = 7" Reel  
4 = 13" Reel  
7 = Bulk Cass.  
9 = Bulk

**A**

**Special Code**  
A = Std. Product

**Contact Factory For**  
1 = Pd/Ag Term

**Contact Factory For**  
Multiples

Temperature Coefficient

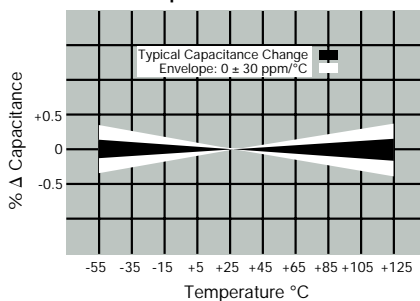

Δ Capacitance vs. Frequency

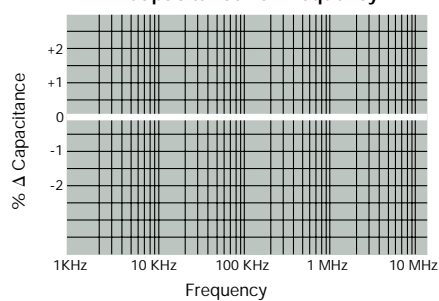

Insulation Resistance vs Temperature

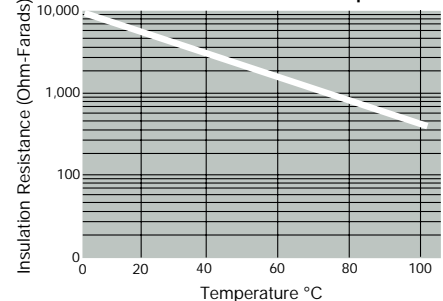

Variation of Impedance with Cap Value  
Impedance vs. Frequency  
0805 - C0G (NP0)  
10 pF vs. 100 pF vs. 1000 pF

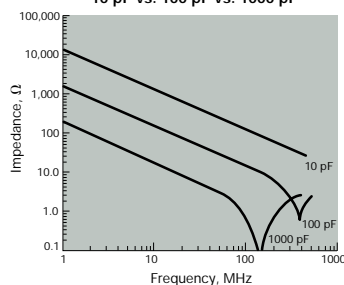

Variation of Impedance with Chip Size  
Impedance vs. Frequency  
1000 pF - C0G (NP0)

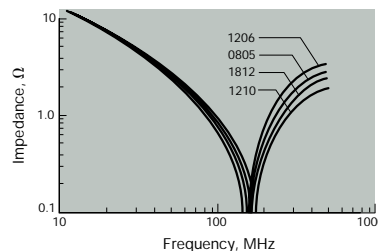

Variation of Impedance with Ceramic Formulation  
Impedance vs. Frequency  
1000 pF - C0G (NP0) vs X7R  
0805

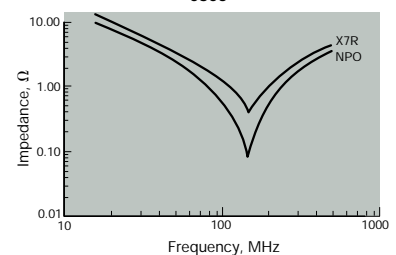

# C0G (NP0) Dielectric

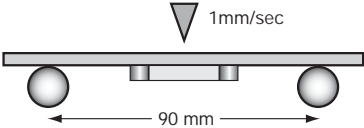

## Specifications and Test Methods

Parameter/Test		NP0 Specification Limits	Measuring Conditions	
Operating Temperature Range		-55°C to +125°C	Temperature Cycle Chamber	
Capacitance		Within specified tolerance	Freq.: 1.0 MHz ± 10% for cap ≤ 1000 pF 1.0 kHz ± 10% for cap > 1000 pF Voltage: 1.0Vrms ± .2V	
Q		<30 pF: Q ≥ 400+20 x Cap Value ≥30 pF: Q ≥ 1000		
Insulation Resistance		100,000MΩ or 1000MΩ - μF, whichever is less	Charge device with rated voltage for 60 ± 5 secs @ room temp/humidity	
Dielectric Strength		No breakdown or visual defects	Charge device with 300% of rated voltage for 1-5 seconds, w/charge and discharge current limited to 50 mA (max) Note: Charge device with 150% of rated voltage for 500V devices.	
Resistance to Flexure Stresses	Appearance	No defects	Deflection: 2mm Test Time: 30 seconds 	
	Capacitance Variation	±5% or ±.5 pF, whichever is greater		
	Q	Meets Initial Values (As Above)		
	Insulation Resistance	≥ Initial Value x 0.3		
Solderability		≥ 95% of each terminal should be covered with fresh solder	Dip device in eutectic solder at 230 ± 5°C for 5.0 ± 0.5 seconds	
Resistance to Solder Heat	Appearance	No defects, <25% leaching of either end terminal	Dip device in eutectic solder at 260°C for 60 seconds. Store at room temperature for 24 ± 2 hours before measuring electrical properties.	
	Capacitance Variation	≤ ±2.5% or ±.25 pF, whichever is greater		
	Q	Meets Initial Values (As Above)		
	Insulation Resistance	Meets Initial Values (As Above)		
Thermal Shock	Dielectric Strength	Meets Initial Values (As Above)	Repeat for 5 cycles and measure after 24 hours at room temperature	
	Appearance	No visual defects	Step 1: -55°C ± 2°	30 ± 3 minutes
	Capacitance Variation	≤ ±2.5% or ±.25 pF, whichever is greater	Step 2: Room Temp	≤ 3 minutes
	Q	Meets Initial Values (As Above)	Step 3: +125°C ± 2°	30 ± 3 minutes
	Insulation Resistance	Meets Initial Values (As Above)	Step 4: Room Temp	≤ 3 minutes
Load Life	Dielectric Strength	Meets Initial Values (As Above)		
	Appearance	No visual defects		
	Capacitance Variation	≤ ±3.0% or ± .3 pF, whichever is greater	Charge device with twice rated voltage in test chamber set at 125°C ± 2°C for 1000 hours (+48, -0).	
	Q (C=Nominal Cap)	≥ 30 pF: Q ≥ 350 ≥10 pF, <30 pF: Q ≥ 275 +5C/2 <10 pF: Q ≥ 200 +10C	Remove from test chamber and stabilize at room temperature for 24 hours before measuring.	
	Insulation Resistance	≥ Initial Value x 0.3 (See Above)		
Load Humidity	Dielectric Strength	Meets Initial Values (As Above)		
	Appearance	No visual defects		
	Capacitance Variation	≤ ±5.0% or ± .5 pF, whichever is greater	Store in a test chamber set at 85°C ± 2°C/ 85% ± 5% relative humidity for 1000 hours (+48, -0) with rated voltage applied.	
	Q	≥ 30 pF: Q ≥ 350 ≥10 pF, <30 pF: Q ≥ 275 +5C/2 <10 pF: Q ≥ 200 +10C	Remove from chamber and stabilize at room temperature for 24 ± 2 hours before measuring.	
Insulation Resistance	≥ Initial Value x 0.3 (See Above)			
	Meets Initial Values (As Above)			

# COG (NP0) Dielectric



## Capacitance Range

PREFERRED SIZES ARE SHADED

SIZE		0201			0402			0603			0805					1206						
Soldering		Reflow Only			Reflow Only			Reflow Only			Reflow/Wave					Reflow/Wave						
Packaging		All Paper			All Paper			All Paper			Paper/Embossed					Paper/Embossed						
(L) Length	MM (in.)	0.60 ± 0.03 (0.024 ± 0.001)			1.00 ± 0.10 (0.040 ± 0.004)			1.60 ± 0.15 (0.063 ± 0.006)			2.01 ± 0.20 (0.079 ± 0.008)					3.20 ± 0.20 (0.126 ± 0.008)						
(W) Width	MM (in.)	0.30 ± 0.03 (0.011 ± 0.001)			0.50 ± 0.10 (0.020 ± 0.004)			0.81 ± 0.15 (0.032 ± 0.006)			1.25 ± 0.20 (0.049 ± 0.008)					1.60 ± 0.20 (0.063 ± 0.008)						
(t) Terminal	MM (in.)	0.15 ± 0.05 (0.006 ± 0.002)			0.25 ± 0.15 (0.010 ± 0.006)			0.35 ± 0.15 (0.014 ± 0.006)			0.50 ± 0.25 (0.020 ± 0.010)					0.50 ± 0.25 (0.020 ± 0.010)						
WVDC		10	16	25	16	25	50	6.3	25	50	100	16	25	50	100	200	16	25	50	100	200	500
Cap (pF)	0.5			A	C	C	C	G	G	G	G	J	J	J	J	J	J	J	J	J	J	J
	1.0			A	C	C	C	G	G	G	G	J	J	J	J	J	J	J	J	J	J	J
	1.2			A	C	C	C	G	G	G	G	J	J	J	J	J	J	J	J	J	J	J
	1.5			A	C	C	C	G	G	G	G	J	J	J	J	J	J	J	J	J	J	J
	1.8			A	C	C	C	G	G	G	G	J	J	J	J	J	J	J	J	J	J	J
Cap (pF)	2.2			A	C	C	C	G	G	G	G	J	J	J	J	J	J	J	J	J	J	J
	2.7			A	C	C	C	G	G	G	G	J	J	J	J	J	J	J	J	J	J	J
	3.3			A	C	C	C	G	G	G	G	J	J	J	J	J	J	J	J	J	J	J
	3.9			A	C	C	C	G	G	G	G	J	J	J	J	J	J	J	J	J	J	J
	4.7			A	C	C	C	G	G	G	G	J	J	J	J	J	J	J	J	J	J	J
Cap (pF)	5.6			A	C	C	C	G	G	G	G	J	J	J	J	J	J	J	J	J	J	J
	6.8			A	C	C	C	G	G	G	G	J	J	J	J	J	J	J	J	J	J	J
	8.2			A	C	C	C	G	G	G	G	J	J	J	J	J	J	J	J	J	J	J
	10			A	C	C	C	G	G	G	G	J	J	J	J	J	J	J	J	J	J	J
	12			A	C	C	C	G	G	G	G	J	J	J	J	J	J	J	J	J	J	J
Cap (pF)	15			A	C	C	C	G	G	G	G	J	J	J	J	J	J	J	J	J	J	J
	18			A	C	C	C	G	G	G	G	J	J	J	J	J	J	J	J	J	J	J
	22			A	C	C	C	G	G	G	G	J	J	J	J	J	J	J	J	J	J	J
	27			A	C	C	C	G	G	G	G	J	J	J	J	J	J	J	J	J	J	J
	33			A				G	G	G	G	J	J	J	J	J	J	J	J	J	J	J
Cap (pF)	39		A				C	C	C	C	G	G	G	G	J	J	J	J	J	J	J	J
	47		A				C	C	C	C	G	G	G	G	J	J	J	J	J	J	J	J
	56		A				C	C	C	C	G	G	G	G	J	J	J	J	J	J	J	J
	68		A				C	C	C	C	G	G	G	G	J	J	J	J	J	J	J	J
	82	A					C	C	C	C	G	G	G	G	J	J	J	J	J	J	J	J
Cap (pF)	100	A				C	C	C	C	G	G	G	G	J	J	J	J	J	J	J	J	J
	120					C	C	C	C	G	G	G	G	J	J	J	J	J	J	J	J	J
	150					C	C	C	C	G	G	G	G	J	J	J	J	J	J	J	J	J
	180					C	C	C	C	G	G	G	G	J	J	J	J	J	J	J	J	J
	220					C	C	C	C	G	G	G	G	J	J	J	J	J	J	J	J	J
Cap (pF)	270					C				G	G	G	G	J	J	J	J	M	J	J	J	M
	330					C				G	G	G	G	J	J	J	J	M	J	J	J	M
	390									G	G	G	G	J	J	J	J	M	J	J	J	M
	470									G	G	G	G	J	J	J	J	M	J	J	J	M
	560									G	G	G	G	J	J	J	J	M	J	J	J	M
Cap (pF)	680									G	G	G	G	J	J	J	J	M	J	J	J	P
	820									G	G	G	G	J	J	J	J		J	J	J	M
	1000									G	G	G		J	J	J	J		J	J	J	Q
	1200													J	J	J	J		J	J	J	Q
	1500													J	J	J	J		J	J	M	Q
Cap (pF)	1800												J	J	J	J		J	J	M	M	
	2200												J	J	J	M		J	J	M	P	
	2700												J	J	J	M		J	J	M	P	
	3300												N	N	N	M		J	J	M	P	
	3900												N	N	N	M		J	J	M	P	
Cap (pF)	4700												N	N	N			J	J	M	P	
	5600												N	N	N			J	J	M		
	6800												N	N	N			M	M			
	8200												N	N	N			M	M			
	Cap (μF)													N					M	M		
Cap (μF)	0.010												N					M	M			
	0.012												N					M	M			
	0.015												N					M	M			
	0.018												N									
	0.022																					
Cap (μF)	0.027																					
	0.033																					
	0.039																					
	0.047																					
	0.068																					
Cap (μF)	0.082																					
	0.1																					
WVDC		10	16	25	16	25	50	6.3	25	50	100	16	25	50	100	200	16	25	50	100	200	500
SIZE		0201			0402			0603			0805					1206						

Letter	A	C	E	G	J	K	M	N	P	Q	X	Y	Z
Max. Thickness	0.33 (0.013)	0.56 (0.022)	0.71 (0.028)	0.86 (0.034)	0.94 (0.037)	1.02 (0.040)	1.27 (0.050)	1.40 (0.055)	1.52 (0.060)	1.78 (0.070)	2.29 (0.090)	2.54 (0.100)	2.79 (0.110)
	PAPER					EMBOSSSED							



# C0G (NP0) Dielectric



## Capacitance Range

PREFERRED SIZES ARE SHADED

SIZE		1210					1812					1825					2225				
Soldering		Reflow Only					Reflow Only					Reflow Only					Reflow Only				
Packaging		Paper/Embossed					All Embossed					All Embossed					All Embossed				
(L) Length	MM (in.)	3.20 ± 0.20 (0.126 ± 0.008)					4.50 ± 0.30 (0.177 ± 0.012)					4.50 ± 0.30 (0.177 ± 0.012)					5.72 ± 0.25 (0.225 ± 0.010)				
(W) Width	MM (in.)	2.50 ± 0.20 (0.098 ± 0.008)					3.20 ± 0.20 (0.126 ± 0.008)					6.40 ± 0.40 (0.252 ± 0.016)					6.35 ± 0.25 (0.250 ± 0.010)				
(t) Terminal	MM (in.)	0.50 ± 0.25 (0.020 ± 0.010)					0.61 ± 0.36 (0.024 ± 0.014)					0.61 ± 0.36 (0.024 ± 0.014)					0.64 ± 0.39 (0.025 ± 0.015)				
WVDC		25	50	100	200	500	25	50	100	200	500	50	100	200	500	50	100	200	500		
Cap (pF)	0.5																				
	1.0																				
	1.2																				
	1.5																				
	1.8																				
	2.2																				
	2.7																				
	3.3																				
	3.9																				
	4.7																				
	5.6																				
	6.8																				
	8.2																				
	10					J															
	12					J															
	15					J															
	18					J															
	22					J															
	27					J															
	33					J															
	39					J															
	47					J															
	56					J															
	68					J															
	82					J															
	100					J															
	120					J															
	150					J															
	180					J															
	220					J															
	270					J															
	330					J															
	390					M															
	470					M															
	560	J	J	J	J	M															
	680	J	J	J	J	M															
	820	J	J	J	J	M															
	1000	J	J	J	J	M	K	K	K	K	M	M	M	M	M		M	M	P		
	1200	J	J	J	M		K	K	K	K	M	M	M	M	M		M	M	P		
	1500	J	J	J	M		K	K	K	K	M	M	M	M	M		M	M	P		
	1800	J	J	J	M		K	K	K	K	M	M	M	M	M		M	M	P		
	2200	J	J	J	O		K	K	K	K	P	M	M	M	M		M	M	P		
	2700	J	J	J	Q		K	K	K	P	Q	M	M	M	M		M	M	P		
	3300	J	J	J			K	K	K	P	Q	M	M	M	M		M	M	P		
	3900	J	J	M			K	K	K	P	Q	M	M	M	M		M	M	P		
	4700	J	J	M			K	K	K	P	Q	M	M	M	M		M	M	P		
	5600	J	J	M			K	K	M	P	X	M	M	M	M		M	M	P		
	6800	J	J				K	K	M	X		M	M	M	M	P	M	M	P		
	8200	J	J				K	M	M	X		M	M	M	M	P	M	M	P		
Cap (µF)	0.010	N	N				K	M	M	X		M	M			P	M	M	P		
	0.012	N	N				K	M				M	M				M	M	P		
	0.015						M	M				M	M				M	M	Y		
	0.018						M	M				P	M				M	M	Y		
	0.022						M	M				P					M	Y	Y		
	0.027						M	P									P	Y	Y		
	0.033						M	P									P	Y	Z		
	0.039						M	P									P	Y	Z		
	0.047						X	P									P				
	0.068						X	X									P				
	0.082						X	X									P				
	0.1						Y	Y									P				
WVDC		25	50	100	200	500	25	50	100	200	500	50	100	200	500	50	100	200	500		

SIZE	1210					1812					1825					2225				
Letter	A	C	E	G	J	K	M	N	P	Q	X	Y	Z							
Max. Thickness	0.33 (0.013)	0.56 (0.022)	0.71 (0.028)	0.86 (0.034)	0.94 (0.037)	1.02 (0.040)	1.27 (0.050)	1.40 (0.055)	1.52 (0.060)	1.78 (0.070)	2.29 (0.090)	2.54 (0.100)	2.79 (0.110)							
	PAPER					EMBOSSSED														



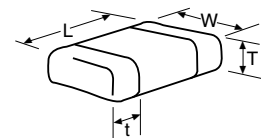

# RF/Microwave COG (NP0) Capacitors



## Ultra Low ESR, "U" Series, COG (NP0) Chip Capacitors

### GENERAL INFORMATION

"U" Series capacitors are COG (NP0) chip capacitors specially designed for "Ultra" low ESR for applications in the communications market. Max ESR and effective capacitance

are met on each value producing lot to lot uniformity. Sizes available are EIA chip sizes 0603, 0805, and 1210.

### DIMENSIONS: inches (millimeters)

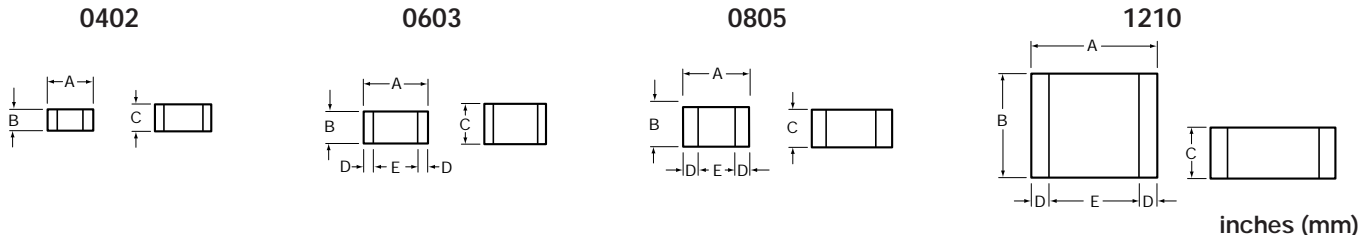

Size	A	B	C	D	E
0402	0.039±0.004 (1.00±0.1)	0.020±0.004 (0.50±0.1)	0.024 (0.6) max	N/A	N/A
0603	0.060±0.010 (1.52±0.25)	0.030±0.010 (0.76±0.25)	0.036 (0.91) max	0.010±0.005 (0.25±0.13)	0.030 (0.76) min
0805	0.079±0.008 (2.01±0.2)	0.049±0.008 (1.25±0.2)	0.040±0.005 (1.02±0.127)	0.020±0.010 (0.51±0.255)	0.020 (0.51) min
1210	0.126±0.008 (3.2±0.2)	0.098±0.008 (2.49±0.2)	0.050±0.005 (1.27±0.127)	0.025±0.015 (0.635±0.381)	0.040 (1.02) min

### HOW TO ORDER

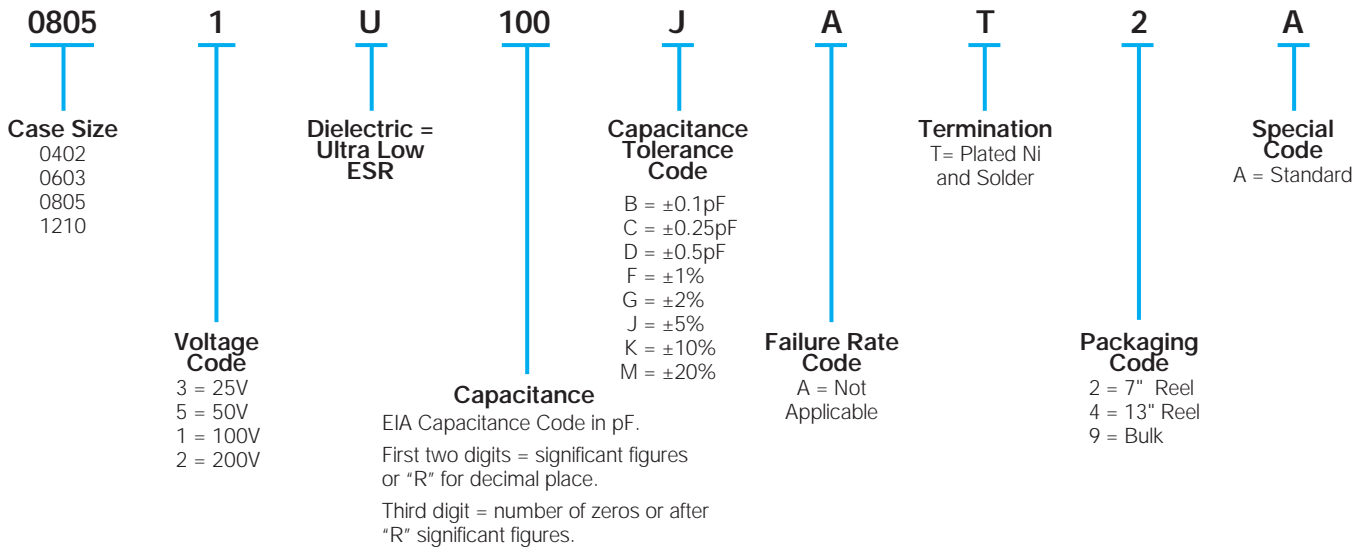

### ELECTRICAL CHARACTERISTICS

#### Capacitance Values and Tolerances:

- Size 0402 - 0.2 pF to 22 pF @ 1 MHz
- Size 0603 - 1.0 pF to 100 pF @ 1 MHz
- Size 0805 - 1.6 pF to 160 pF @ 1 MHz
- Size 1210 - 2.4 pF to 1000 pF @ 1 MHz

#### Temperature Coefficient of Capacitance (TC):

0±30 ppm/°C (-55° to +125°C)

#### Insulation Resistance (IR):

- 10<sup>12</sup> Ω min. @ 25°C and rated WVDC
- 10<sup>11</sup> Ω min. @ 125°C and rated WVDC

#### Working Voltage (WVDC):

- Size Working Voltage
- 0402 - 50, 25 WVDC
- 0603 - 200, 100, 50 WVDC
- 0805 - 200, 100 WVDC
- 1210 - 200, 100 WVDC

#### Dielectric Working Voltage (DWV):

250% of rated WVDC

#### Equivalent Series Resistance Typical (ESR):

- 0402 - See Performance Curve, page 9
- 0603 - See Performance Curve, page 9
- 0805 - See Performance Curve, page 9
- 1210 - See Performance Curve, page 9

**Marking:** Laser marking EIA J marking standard (except 0603) (capacitance code and tolerance upon request).

### MILITARY SPECIFICATIONS

Meets or exceeds the requirements of MIL-C-55681

# RF/Microwave COG (NP0) Capacitors



## Ultra Low ESR, "U" Series, COG (NP0) Chip Capacitors

### CAPACITANCE RANGE

Cap (pF)	Available	Size			
	Tolerance	0402	0603	0805	1210
0.2	B,C	50V	N/A	N/A	N/A
0.3	↑	↓	↓	↓	↓
0.4	↓	↓	↓	↓	↓
0.5	B,C	↓	↓	↓	↓
0.6	B,C,D	↓	↓	↓	↓
0.7	↑	↓	↓	↓	↓
0.8	↓	↓	↓	↓	↓
0.9	B,C,D	↓	↓	↓	↓

Cap (pF)	Available	Size			
	Tolerance	0402	0603	0805	1210
1.0	B,C,D	50V	200V	200V	N/A
1.1	↑	↓	↓	↓	↓
1.2	↑	↓	↓	↓	↓
1.3	↑	↓	↓	↓	↓
1.4	↑	↓	↓	↓	↓
1.5	↑	↓	↓	↓	↓
1.6	↑	↓	↓	↓	↓
1.7	↑	↓	↓	↓	↓
1.8	↑	↓	↓	↓	↓
1.9	↑	↓	↓	↓	↓
2.0	↑	↓	↓	↓	↓
2.1	↑	↓	↓	↓	↓
2.2	↑	↓	↓	↓	↓
2.4	↑	↓	↓	↓	200V
2.7	↑	↓	↓	↓	↓
3.0	↑	↓	↓	↓	↓
3.3	↑	↓	↓	↓	↓
3.6	↑	↓	↓	↓	↓
3.9	↑	↓	↓	↓	↓
4.3	↑	↓	↓	↓	↓
4.7	↑	↓	↓	↓	↓
5.1	↑	↓	↓	↓	↓
5.6	↑	↓	↓	↓	↓
6.2	B,C,D	↓	↓	↓	↓
6.8	B,C,J,K,M	↓	↓	↓	↓

Cap (pF)	Available	Size			
	Tolerance	0402	0603	0805	1210
7.5	B,C,J,K,M	50V	200V	200V	200V
8.2	↓	↓	↓	↓	↓
9.1	B,C,J,K,M	↓	↓	↓	↓
10	F,G,J,K,M	↓	↓	↓	↓
11	↑	↓	↓	↓	↓
12	↑	↓	↓	↓	↓
13	↑	↓	↓	↓	↓
15	↑	↓	↓	↓	↓
18	↑	↓	↓	↓	↓
20	↑	↓	↓	↓	↓
22	↑	↓	↓	↓	↓
24	↑	↓	↓	↓	↓
27	↑	↓	↓	↓	↓
30	↑	50V	↓	↓	↓
33	↑	N/A	↓	↓	↓
36	↑	↓	↓	↓	↓
39	↑	↓	↓	↓	↓
43	↑	↓	↓	↓	↓
47	↑	↓	↓	↓	↓
51	↑	↓	↓	↓	↓
56	↑	↓	↓	↓	↓
68	↑	↓	↓	↓	↓
75	↑	↓	↓	↓	↓
82	↑	↓	↓	↓	↓
91	F,G,J,K,M	↓	↓	↓	↓

Cap (pF)	Available	Size			
	Tolerance	0402	0603	0805	1210
100	F,G,J,K,M	N/A	100V	200V	200V
110	↑	↓	50V	↓	↓
120	↑	↓	↓	↓	↓
130	↑	↓	↓	↓	↓
140	↑	↓	↓	↓	↓
150	↑	↓	↓	↓	↓
160	↑	↓	↓	↓	↓
180	↑	↓	↓	↓	↓
200	↑	↓	↓	↓	↓
220	↑	↓	↓	↓	↓
270	↑	↓	↓	↓	↓
300	↑	↓	↓	↓	↓
330	↑	↓	↓	↓	↓
360	↑	↓	↓	↓	↓
390	↑	↓	↓	↓	↓
430	↑	↓	↓	↓	↓
470	↑	↓	↓	↓	↓
510	↑	↓	↓	↓	↓
560	↑	↓	↓	↓	↓
620	↑	↓	↓	↓	↓
680	↑	↓	↓	↓	↓
750	↑	↓	↓	↓	↓
820	↑	↓	↓	↓	↓
910	↑	↓	↓	↓	↓
1000	F,G,J,K,M	↓	↓	↓	↓

### ULTRA LOW ESR, "U" SERIES

TYPICAL ESR vs. FREQUENCY  
0402 "U" SERIES

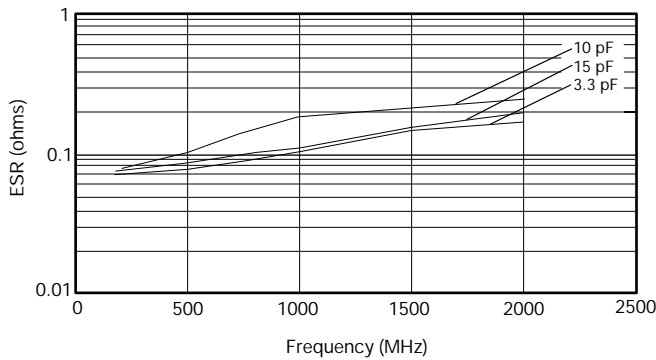

TYPICAL ESR vs. FREQUENCY  
0603 "U" SERIES

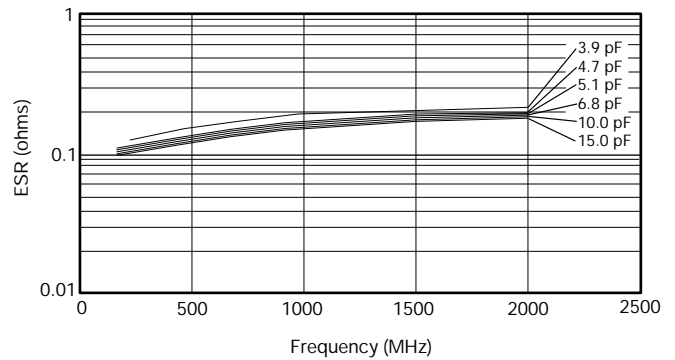

TYPICAL ESR vs. FREQUENCY  
0805 "U" SERIES

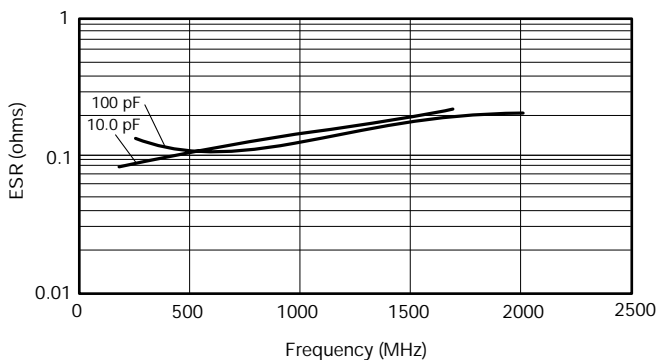

TYPICAL ESR vs. FREQUENCY  
1210 "U" SERIES

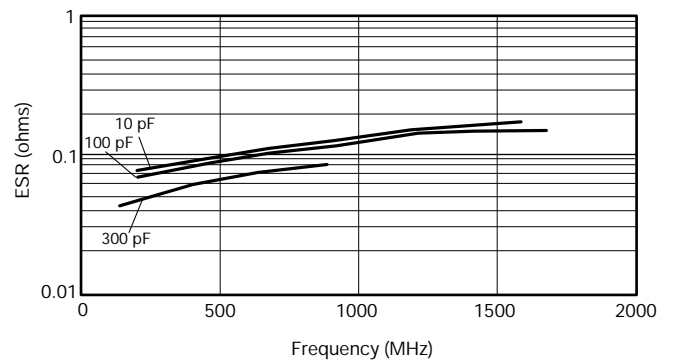

ESR Measured on the Boonton 34A



# RF/Microwave C0G (NP0) Capacitors



Ultra Low ESR, "U" Series, C0G (NP0) Chip Capacitors

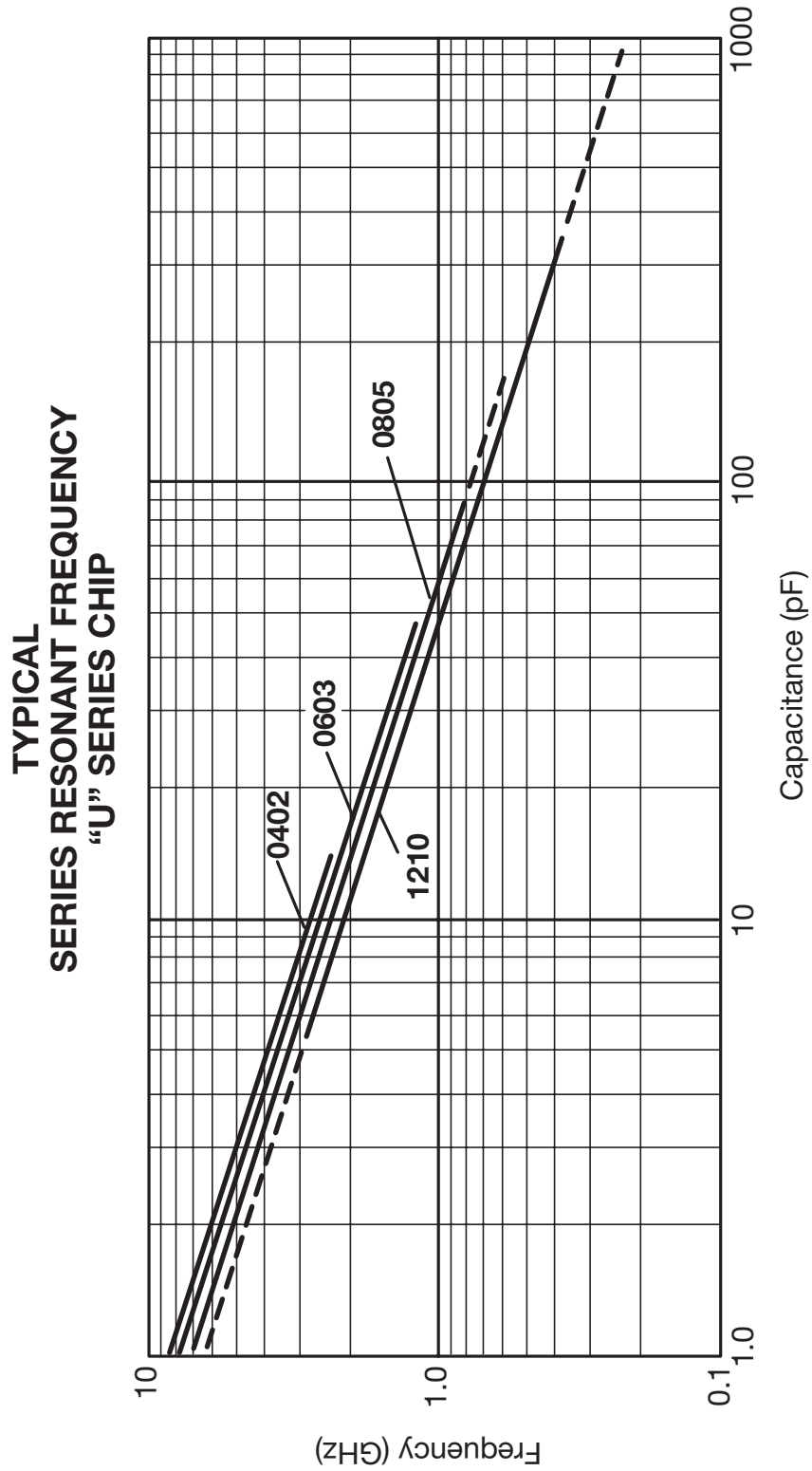

### "U" SERIES KITS

Solder Plated, Nickel Barrier

#### 0402

Kit 5000 UZ*			
Cap. Value pF	Tol. †	Cap. Value pF	Tol. †
0.5	B	4.7	B
1.0	B	5.6	B
1.5	B	6.8	B
1.8	B	8.2	B
2.2	B	10.0	J
2.4	B	12.0	J
3.0	B	15.0	J
3.6	B		

\* 150 Capacitors 10 each of 15 values.

#### 0603

Kit 4000 UZ**			
Cap. Value pF	Tol. †	Cap. Value pF	Tol. †
1.0	±.25pF	6.8	±.25pF
1.2	±.25pF	7.5	±.25pF
1.5	±.25pF	8.2	±.25pF
1.8	±.25pF	10.0	±5%
2.0	±.25pF	12.0	±5%
2.4	±.25pF	15.0	±5%
2.7	±.25pF	18.0	±5%
3.0	±.25pF	22.0	±5%
3.3	±.25pF	27.0	±5%
3.9	±.25pF	33.0	±5%
4.7	±.25pF	39.0	±5%
5.6	±.25pF	47.0	±5%

\*\* 240 Capacitors 10 each of 24 values.

#### 0805

Kit 3000 UZ***					
Cap. Value pF	Tol. †	Cap. Value pF	Tol. †	Cap. Value pF	Tol. †
1.0	C	7.5	C	33	J
1.5	C	8.2	C	36	J
2.2	C	9.1	C	39	J
2.4	C	10.0	J	47	J
2.7	C	12.0	J	56	J
3.0	C	15.0	J	68	J
3.3	C	18.0	J	82	J
3.9	C	22.0	J	100	J
4.7	C	24.0	J	130	J
5.6	C	27.0	J	160	J

\*\*\* 300 Capacitors 10 each of 30 values.

#### 1210

Kit 3500 UZ***					
Cap. Value pF	Tol. †	Cap. Value pF	Tol. †	Cap. Value pF	Tol. †
2.2	C	18	J	68	J
2.7	C	20	J	82	J
4.7	C	24	J	100	J
5.1	C	27	J	120	J
6.8	C	30	J	130	J
8.2	C	36	J	240	J
9.1	C	39	J	300	J
10	J	47	J	390	J
13	J	51	J	470	J
15	J	56	J	680	J

†Tolerance – B = ±0.1pF  
 C = ±0.25pF  
 J = ±5%

# X7R Dielectric

## General Specifications

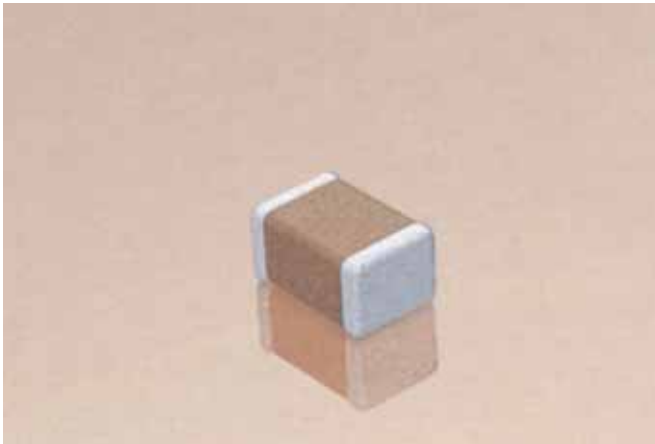

X7R formulations are called "temperature stable" ceramics and fall into EIA Class II materials. X7R is the most popular of these intermediate dielectric constant materials. Its temperature variation of capacitance is within  $\pm 15\%$  from  $-55^{\circ}\text{C}$  to  $+125^{\circ}\text{C}$ . This capacitance change is non-linear.

Capacitance for X7R varies under the influence of electrical operating conditions such as voltage and frequency.

X7R dielectric chip usage covers the broad spectrum of industrial applications where known changes in capacitance due to applied voltages are acceptable.

### PART NUMBER (see page 2 for complete part number explanation)

**0805**

Size  
(L" x W")

**5**

Voltage  
4V = 4  
6.3V = 6  
10V = Z  
16V = Y  
25V = 3  
50V = 5  
100V = 1  
200V = 2  
500V = 7

**C**

Dielectric  
X7R = C

**103**

Capacitance Code (In pF)  
2 Sig. Digits +  
Number of  
Zeros

**M**

Capacitance Tolerance  
J =  $\pm 5\%$   
K =  $\pm 10\%$   
M =  $\pm 20\%$

**A**

Failure Rate  
A = Not  
Applicable

**T**

Terminations  
T = Plated Ni  
and Sn  
7 = Gold  
Plated

**2**

Packaging  
2 = 7" Reel  
4 = 13" Reel  
7 = Bulk Cass.  
9 = Bulk

**A**

Special Code  
A = Std.  
Product

Contact  
Factory For  
Multiples

X7R Dielectric  
Typical Temperature Coefficient

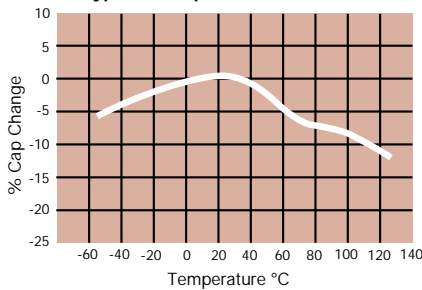

$\Delta$  Capacitance vs. Frequency

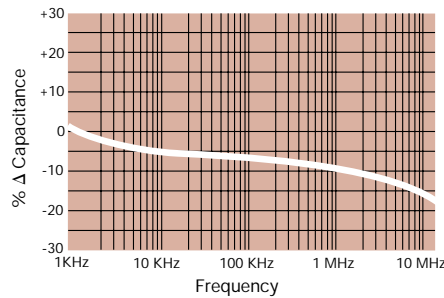

Insulation Resistance vs Temperature

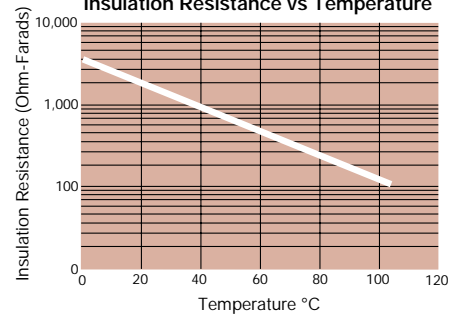

Variation of Impedance with Cap Value  
Impedance vs. Frequency  
1,000 pF vs. 10,000 pF - X7R  
0805

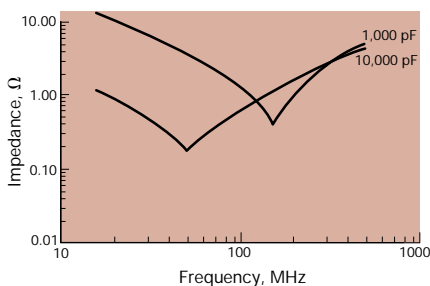

Variation of Impedance with Chip Size  
Impedance vs. Frequency  
10,000 pF - X7R

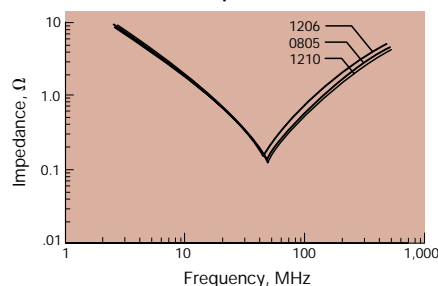

Variation of Impedance with Chip Size  
Impedance vs. Frequency  
100,000 pF - X7R

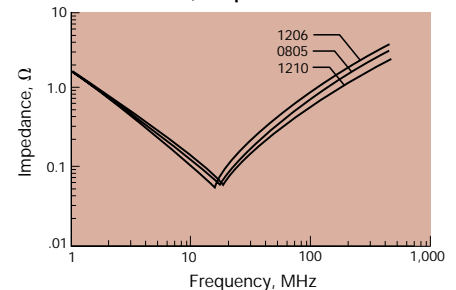

# X7R Dielectric

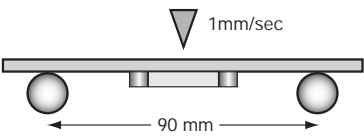

## Specifications and Test Methods

Parameter/Test		X7R Specification Limits	Measuring Conditions	
Operating Temperature Range		-55°C to +125°C	Temperature Cycle Chamber	
Capacitance		Within specified tolerance	Freq.: 1.0 kHz $\pm$ 10% Voltage: 1.0Vrms $\pm$ .2V For Cap > 10 $\mu$ F, 0.5Vrms @ 120Hz	
Dissipation Factor		$\leq$ 2.5% for $\geq$ 50V DC rating $\leq$ 3.0% for 25V DC rating $\leq$ 3.5% for 16V DC rating $\leq$ 5.0% for $\leq$ 10V DC rating		
Insulation Resistance		100,000M $\Omega$ or 1000M $\Omega$ - $\mu$ F, whichever is less	Charge device with rated voltage for 120 $\pm$ 5 secs @ room temp/humidity	
Dielectric Strength		No breakdown or visual defects	Charge device with 300% of rated voltage for 1-5 seconds, w/charge and discharge current limited to 50 mA (max) Note: Charge device with 150% of rated voltage for 500V devices.	
Resistance to Flexure Stresses	Appearance	No defects	Deflection: 2mm Test Time: 30 seconds 	
	Capacitance Variation	$\leq$ $\pm$ 12%		
	Dissipation Factor	Meets Initial Values (As Above)		
	Insulation Resistance	$\geq$ Initial Value x 0.3		
Solderability		$\geq$ 95% of each terminal should be covered with fresh solder	Dip device in eutectic solder at 230 $\pm$ 5°C for 5.0 $\pm$ 0.5 seconds	
Resistance to Solder Heat	Appearance	No defects, <25% leaching of either end terminal	Dip device in eutectic solder at 260°C for 60 seconds. Store at room temperature for 24 $\pm$ 2 hours before measuring electrical properties.	
	Capacitance Variation	$\leq$ $\pm$ 7.5%		
	Dissipation Factor	Meets Initial Values (As Above)		
	Insulation Resistance	Meets Initial Values (As Above)		
	Dielectric Strength	Meets Initial Values (As Above)		
Thermal Shock	Appearance	No visual defects	Step 1: -55°C $\pm$ 2°	30 $\pm$ 3 minutes
	Capacitance Variation	$\leq$ $\pm$ 7.5%	Step 2: Room Temp	$\leq$ 3 minutes
	Dissipation Factor	Meets Initial Values (As Above)	Step 3: +125°C $\pm$ 2°	30 $\pm$ 3 minutes
	Insulation Resistance	Meets Initial Values (As Above)	Step 4: Room Temp	$\leq$ 3 minutes
	Dielectric Strength	Meets Initial Values (As Above)	Repeat for 5 cycles and measure after 24 $\pm$ 2 hours at room temperature	
Load Life	Appearance	No visual defects	Charge device with twice rated voltage in test chamber set at 125°C $\pm$ 2°C for 1000 hours (+48, -0)  Remove from test chamber and stabilize at room temperature for 24 $\pm$ 2 hours before measuring.	
	Capacitance Variation	$\leq$ $\pm$ 12.5%		
	Dissipation Factor	$\leq$ Initial Value x 2.0 (See Above)		
	Insulation Resistance	$\geq$ Initial Value x 0.3 (See Above)		
	Dielectric Strength	Meets Initial Values (As Above)		
Load Humidity	Appearance	No visual defects	Store in a test chamber set at 85°C $\pm$ 2°C/ 85% $\pm$ 5% relative humidity for 1000 hours (+48, -0) with rated voltage applied.  Remove from chamber and stabilize at room temperature and humidity for 24 $\pm$ 2 hours before measuring.	
	Capacitance Variation	$\leq$ $\pm$ 12.5%		
	Dissipation Factor	$\leq$ Initial Value x 2.0 (See Above)		
	Insulation Resistance	$\geq$ Initial Value x 0.3 (See Above)		
	Dielectric Strength	Meets Initial Values (As Above)		

# X7R Dielectric Capacitance Range



## PREFERRED SIZES ARE SHADED

	-		-		-				-				-										
SIZE	0201		0402		0603				0805				1206										
Soldering	Reflow Only		Reflow Only		Reflow Only				Reflow/Wave				Reflow/Wave										
Packaging	All Paper		All Paper		All Paper				Paper/Embossed				Paper/Embossed										
(L) Length	MM 0.60 ± 0.03 (in.) (0.024 ± 0.001)	1.00 ± 0.10 (0.040 ± 0.004)		1.60 ± 0.15 (0.063 ± 0.006)				2.01 ± 0.20 (0.079 ± 0.008)				3.20 ± 0.20 (0.126 ± 0.008)											
(W) Width	MM 0.30 ± 0.03 (in.) (0.011 ± 0.001)	0.50 ± 0.10 (0.020 ± 0.004)		0.81 ± 0.15 (0.032 ± 0.006)				1.25 ± 0.20 (0.049 ± 0.008)				1.60 ± 0.20 (0.063 ± 0.008)											
(t) Terminal	MM 0.15 ± 0.05 (in.) (0.006 ± 0.002)	0.25 ± 0.15 (0.010 ± 0.006)		0.35 ± 0.15 (0.014 ± 0.006)				0.50 ± 0.25 (0.020 ± 0.010)				0.50 ± 0.25 (0.020 ± 0.010)											
WVDC	16	16	25	50	10	16	25	50	100	10	16	25	50	100	200	10	16	25	50	100	200	500	
Cap (pF)	100	A																					
	150	A																					
	220	A		C																			
	330	A		C			G	G	J	J	J	J	J	J	J							K	
	470	A		C			G	G	J	J	J	J	J	J	J							K	
	680	A		C			G	G	J	J	J	J	J	J	J							K	
	1000	A		C			G	G	J	J	J	J	J	J	J							K	
	1500			C			G	G	J	J	J	J	J	J	J	J	J	J	J	J	J	M	
	2200			C			G	G	J	J	J	J	J	J	J	J	J	J	J	J	J	P	
	3300		C	C			G	G	J	J	J	J	J	J	J	J	J	J	J	J	J	M	
	4700		C	C			G	G	J	J	J	J	J	J	J	J	J	J	J	J	J	M	
	6800		C	C			G	G	J	J	J	J	J	J	J	J	J	J	J	J	J	P	
Cap (μF)	0.010	C					G	G	J	J	J	J	J	J	J	J	J	J	J	J	J	P	
	0.015	C					G	G	J	J	J	J	J	J	J	J	J	J	J	J	J		
	0.022	C					G	G	J	J	J	J	J	J	J	J	J	J	J	J	J	M	
	0.033						G	G	J	J	J	J	J	M		J	J	J	J	J	J	M	
	0.047						G	G	J	J	J	J	J	M		J	J	J	J	J	J	M	
	0.068						G	G	J	J	J	J	J			J	J	J	J	J	J	P	
	0.10						G	G	J	J	J	J	J			J	J	J	J	J	J	M	
	0.15						G	G	J	J	J	J	J			J	J	J	J	J	J		
	0.22						G	G	J	J	J	J	M			J	J	J	J	J	J		
	0.33								M	M						J	J	M	M				
	0.47								N	M						M	M	M					
	0.68								N							M	M	M					
	1.0								N							M	M	Q					
	1.5															P							
	2.2															Q							
	3.3																						
	4.7																						
	10																						
	22																						
	47																						
	100																						
WVDC	16	16	25	50	10	16	25	50	100	10	16	25	50	100	200	10	16	25	50	100	200	500	

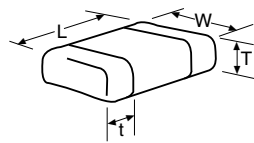

Letter	A	C	E	G	J	K	M	N	P	Q	X	Y	Z
Max. Thickness	0.33 (0.013)	0.56 (0.022)	0.71 (0.028)	0.86 (0.034)	0.94 (0.037)	1.02 (0.040)	1.27 (0.050)	1.40 (0.055)	1.52 (0.060)	1.78 (0.070)	2.29 (0.090)	2.54 (0.100)	2.79 (0.110)
	PAPER					EMBOSSSED							



# X7R Dielectric

## Capacitance Range



PREFERRED SIZES ARE SHADED

SIZE	1210								1812				1825		2220				2225	
	Reflow Only								Reflow Only				Reflow Only		Reflow Only				Reflow Only	
Soldering	Paper/Embossed								All Embossed				All Embossed		All Embossed				All Embossed	
Packaging	Paper/Embossed								All Embossed				All Embossed		All Embossed				All Embossed	
(L) Length	3.20 ± 0.20 (0.126 ± 0.008)								4.50 ± 0.30 (0.177 ± 0.012)				4.50 ± 0.30 (0.177 ± 0.012)		5.70 ± 0.40 (0.225 ± 0.016)				5.72 ± 0.25 (0.225 ± 0.010)	
(W) Width	2.50 ± 0.20 (0.098 ± 0.008)								3.20 ± 0.20 (0.126 ± 0.008)				6.40 ± 0.40 (0.252 ± 0.016)		5.00 ± 0.40 (0.197 ± 0.016)				6.35 ± 0.25 (0.250 ± 0.010)	
(t) Terminal	0.50 ± 0.25 (0.020 ± 0.010)								0.61 ± 0.36 (0.024 ± 0.014)				0.61 ± 0.36 (0.024 ± 0.014)		0.64 ± 0.39 (0.025 ± 0.015)				0.64 ± 0.39 (0.025 ± 0.015)	
WVDC	10	16	25	50	100	200	500	50	100	200	500	50	100	6.3	50	100	200	50	100	
Cap (pF)	100																			
	150																			
	220																			
	330																			
	470																			
	680																			
	1000																			
	1500	J	J	J	J	J	J	M												
	2200	J	J	J	J	J	J	M												
	3300	J	J	J	J	J	J	M												
	4700	J	J	J	J	J	J	M												
	6800	J	J	J	J	J	J	M												
Cap (µF)	0.010	J	J	J	J	J	J	M	K	K	K	K	M	M	X	X	X	X	M	P
	0.015	J	J	J	J	J	J	P	K	K	K	P	M	M	X	X	X	X	M	P
	0.022	J	J	J	J	J	J	Q	K	K	K	P	M	M	X	X	X	X	M	P
	0.033	J	J	J	J	J	J		K	K	K	X	M	M	X	X	X	X	M	P
	0.047	J	J	J	J	J	J		K	K	K	Z	M	M	X	X	X	X	M	P
	0.068	J	J	J	J	J	M		K	K	K		M	M	X	X	X	X	M	P
	0.10	J	J	J	J	J	M		K	K	K		M	M	X	X	X	X	M	P
	0.15	J	J	J	J	M			K	K	P		M	M	X	X	X	X	M	P
	0.22	J	J	J	J	P			K	K	P		M	M	X	X	X		M	P
	0.33	J	J	J	J	Z			K	M			M	M	X	X	X		M	P
	0.47	M	M	M	M	Z			K	P			M	M	X	X	X		M	P
	0.68	M	M	P	X	Z			M	O			M		X	X	X		M	P
	1.0	N	N	P	X	Z			M	X			M				Z		M	P
	1.5	N	N										M						M	X
	2.2			X					Z										M	
	3.3																			
	4.7	Q	Z																	
	10	Z																		
	22																			
	47																			
	100																			

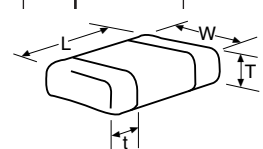

Letter	A	C	E	G	J	K	M	N	P	Q	X	Y	Z
Max. Thickness	0.33 (0.013)	0.56 (0.022)	0.71 (0.028)	0.86 (0.034)	0.94 (0.037)	1.02 (0.040)	1.27 (0.050)	1.40 (0.055)	1.52 (0.060)	1.78 (0.070)	2.29 (0.090)	2.54 (0.100)	2.79 (0.110)
	PAPER					EMBOSSD							



# X7S Dielectric

## General Specifications

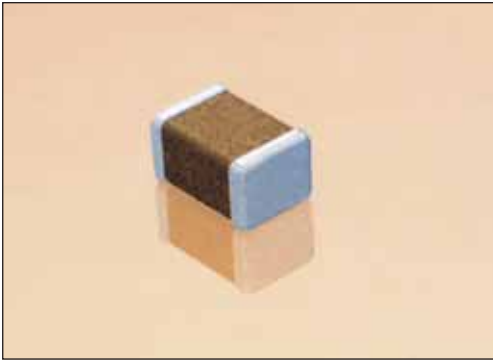

### GENERAL DESCRIPTION

X7S formulations are called “temperature stable” ceramics and fall into EIA Class II materials. X7S is the most popular of these intermediate dielectric constant materials. Its temperature variation of capacitance is within  $\pm 22\%$  from  $-55^{\circ}\text{C}$  to  $+125^{\circ}\text{C}$ . This capacitance change is non-linear.

Capacitance for X7S varies under the influence of electrical operating conditions such as voltage and frequency.

X7S dielectric chip usage covers the broad spectrum of industrial applications where known changes in capacitance due to applied voltages are acceptable.

### PART NUMBER (see page 2 for complete part number explanation)

**1206**

Size  
(L" x W")

**Z**

Voltage  
4 = 4V  
6 = 6.3V  
Z = 10V  
Y = 16V  
3 = 25V  
5 = 50V  
1 = 100V  
2 = 200V

**Z**

Dielectric  
Z = X7S

**105**

Capacitance Code (In pF)  
2 Sig. Digits + Number of Zeros

**M**

Capacitance Tolerance  
K =  $\pm 10\%$   
M =  $\pm 20\%$

**A**

Failure Rate  
A = N/A

**T**

Terminations  
T = Plated Ni and Sn

**2**

Packaging  
2 = 7" Reel  
4 = 13" Reel  
7 = Bulk Cass.

**A**

Special Code  
A = Std. Product

### TYPICAL ELECTRICAL CHARACTERISTICS

**X7S Dielectric Typical Temperature Coefficient**

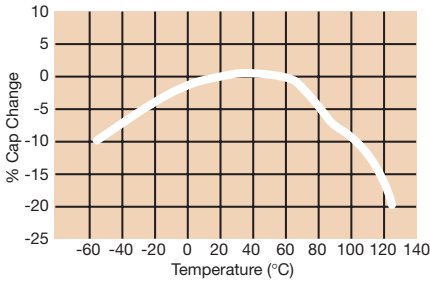

**$\Delta$  Capacitance vs. Frequency**

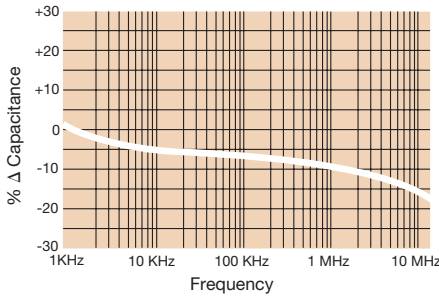

**Insulation Resistance vs Temperature**

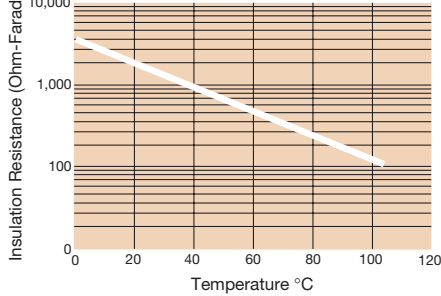

**Variation of Impedance with Cap Value Impedance vs. Frequency 1,000 pF vs. 10,000 pF - X7S 0805**

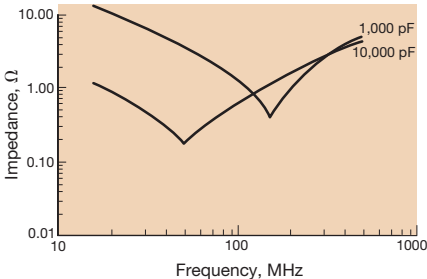

**Variation of Impedance with Chip Size Impedance vs. Frequency 10,000 pF - X7S**

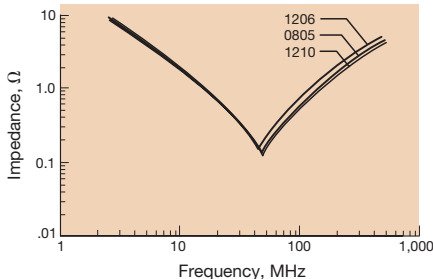

**Variation of Impedance with Chip Size Impedance vs. Frequency 100,000 pF - X7S**

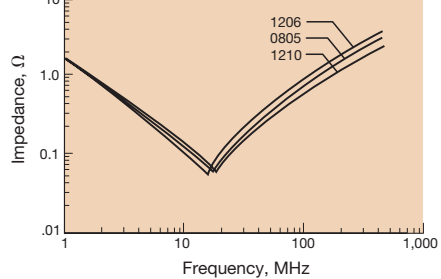

# X7S Dielectric

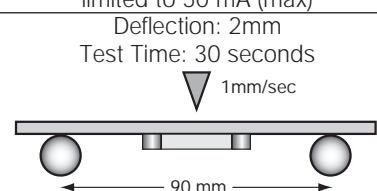

## Specifications and Test Methods

Parameter/Test		X7S Specification Limits	Measuring Conditions	
Operating Temperature Range		-55°C to +125°C	Temperature Cycle Chamber	
Capacitance		Within specified tolerance	Freq.: 1.0 kHz ± 10% Voltage: 1.0Vrms ± .2V For Cap > 10 µF, 0.5Vrms @ 120Hz	
Dissipation Factor		$\leq 2.5\%$ for $\geq 50V$ DC rating $\leq 3.0\%$ for 25V DC rating $\leq 3.5\%$ for 16V DC rating $\leq 5.0\%$ for $\leq 10V$ DC rating		
Insulation Resistance		100,000MΩ or 1000MΩ - µF, whichever is less	Charge device with rated voltage for 120 ± 5 secs @ room temp/humidity	
Dielectric Strength		No breakdown or visual defects	Charge device with 300% of rated voltage for 1-5 seconds, w/charge and discharge current limited to 50 mA (max)	
Resistance to Flexure Stresses	Appearance	No defects	Deflection: 2mm Test Time: 30 seconds 	
	Capacitance Variation	$\leq \pm 12\%$		
	Dissipation Factor	Meets Initial Values (As Above)		
	Insulation Resistance	$\geq$ Initial Value x 0.3		
Solderability		$\geq 95\%$ of each terminal should be covered with fresh solder	Dip device in eutectic solder at 230 ± 5°C for 5.0 ± 0.5 seconds	
Resistance to Solder Heat	Appearance	No defects, <25% leaching of either end terminal	Dip device in eutectic solder at 260°C for 60 seconds. Store at room temperature for 24 ± 2 hours before measuring electrical properties.	
	Capacitance Variation	$\leq \pm 7.5\%$		
	Dissipation Factor	Meets Initial Values (As Above)		
	Insulation Resistance	Meets Initial Values (As Above)		
	Dielectric Strength	Meets Initial Values (As Above)		
Thermal Shock	Appearance	No visual defects	Step 1: -55°C ± 2°	30 ± 3 minutes
	Capacitance Variation	$\leq \pm 7.5\%$	Step 2: Room Temp	$\leq 3$ minutes
	Dissipation Factor	Meets Initial Values (As Above)	Step 3: +125°C ± 2°	30 ± 3 minutes
	Insulation Resistance	Meets Initial Values (As Above)	Step 4: Room Temp	$\leq 3$ minutes
	Dielectric Strength	Meets Initial Values (As Above)	Repeat for 5 cycles and measure after 24 ± 2 hours at room temperature	
Load Life	Appearance	No visual defects	Charge device with twice rated voltage in test chamber set at 125°C ± 2°C for 1000 hours (+48, -0)  Remove from test chamber and stabilize at room temperature for 24 ± 2 hours before measuring.	
	Capacitance Variation	$\leq \pm 12.5\%$		
	Dissipation Factor	$\leq$ Initial Value x 2.0 (See Above)		
	Insulation Resistance	$\geq$ Initial Value x 0.3 (See Above)		
	Dielectric Strength	Meets Initial Values (As Above)		
Load Humidity	Appearance	No visual defects	Store in a test chamber set at 85°C ± 2°C/ 85% ± 5% relative humidity for 1000 hours (+48, -0) with rated voltage applied.  Remove from chamber and stabilize at room temperature and humidity for 24 ± 2 hours before measuring.	
	Capacitance Variation	$\leq \pm 12.5\%$		
	Dissipation Factor	$\leq$ Initial Value x 2.0 (See Above)		
	Insulation Resistance	$\geq$ Initial Value x 0.3 (See Above)		
	Dielectric Strength	Meets Initial Values (As Above)		

# X7S Dielectric

## Capacitance Range



### PREFERRED SIZES ARE SHADED

SIZE	0402	0603	0805	1206	1210
<b>Soldering</b>	Reflow Only	Reflow Only	Reflow/Wave	Reflow/Wave	Reflow Only
<b>Packaging</b>	All Paper	All Paper	Paper/Embossed	Paper/Embossed	Paper/Embossed
(L) Length	MM (in.) 1.00 ± 0.10 (0.040 ± 0.004)	MM (in.) 1.60 ± 0.15 (0.063 ± 0.006)	MM (in.) 2.01 ± 0.20 (0.079 ± 0.008)	MM (in.) 3.20 ± 0.20 (0.126 ± 0.008)	MM (in.) 3.20 ± 0.20 (0.126 ± 0.008)
(W) Width	MM (in.) 0.50 ± 0.10 (0.020 ± 0.004)	MM (in.) 0.81 ± 0.15 (0.032 ± 0.006)	MM (in.) 1.25 ± 0.20 (0.049 ± 0.008)	MM (in.) 1.60 ± 0.20 (0.063 ± 0.008)	MM (in.) 2.50 ± 0.20 (0.098 ± 0.008)
(t) Terminal	MM (in.) 0.25 ± 0.15 (0.010 ± 0.006)	MM (in.) 0.35 ± 0.15 (0.014 ± 0.006)	MM (in.) 0.50 ± 0.25 (0.020 ± 0.010)	MM (in.) 0.50 ± 0.25 (0.020 ± 0.010)	MM (in.) 0.50 ± 0.25 (0.020 ± 0.010)
WVDC	6.3	6.3	4	6.3   10	6.3
Cap (pF)					
100					
150					
220					
330					
470					
680					
1000					
1500					
2200					
Cap (µF)					
0.010					
0.015					
0.022					
0.033	C				
0.047	C				
0.068	C				
0.10	C				
0.15					
0.22					
0.33		G			
0.47		G			
0.68		G			
1.0		G			
1.5			N	O	
2.2			N	O	
3.3			N	O	
4.7			N	O	O
10					
22					Z
47					
100					
WVDC	6.3	6.3	4	6.3   10	6.3
<b>SIZE</b>	<b>0402</b>	<b>0603</b>	<b>0805</b>	<b>1206</b>	<b>1210</b>

Letter	A	C	E	G	J	K	M	N	P	Q	X	Y	Z
Max. Thickness	0.33 (0.013)	0.56 (0.022)	0.71 (0.028)	0.86 (0.034)	0.94 (0.037)	1.02 (0.040)	1.27 (0.050)	1.40 (0.055)	1.52 (0.060)	1.78 (0.070)	2.29 (0.090)	2.54 (0.100)	2.79 (0.110)

PAPER

EMBOSSSED



# X5R Dielectric

## General Specifications

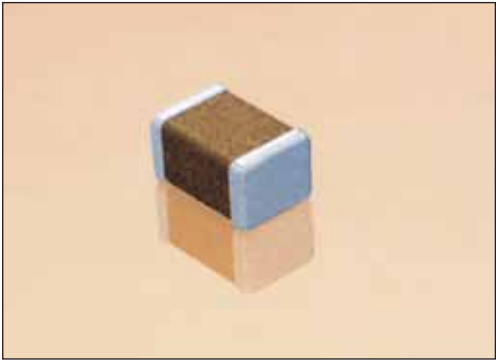

### GENERAL DESCRIPTION

- General Purpose Dielectric for Ceramic Capacitors
- EIA Class II Dielectric
- Temperature variation of capacitance is within  $\pm 15\%$  from  $-55^{\circ}\text{C}$  to  $+85^{\circ}\text{C}$
- Well suited for decoupling and filtering applications
- Available in High Capacitance values (up to  $100\mu\text{F}$ )

### PART NUMBER (see page 2 for complete part number explanation)

**2220**

Size  
(L" x W")

**6**

Voltage  
4 = 4V  
6 = 6.3V  
Z = 10V  
Y = 16V  
3 = 25V  
D = 35V  
5 = 50V

**D**

Dielectric  
D = X5R

**107**

Capacitance Code (In pF)  
2 Sig. Digits + Number of Zeros

**M**

Capacitance Tolerance  
K =  $\pm 10\%$   
M =  $\pm 20\%$

**A**

Failure Rate  
A = N/A

**T**

Terminations  
T = Plated Ni and Sn

**2**

Packaging  
2 = 7" Reel  
4 = 13" Reel  
7 = Bulk Cass.  
9 = Bulk

**A**

Special Code  
A = Std.

### TYPICAL ELECTRICAL CHARACTERISTICS

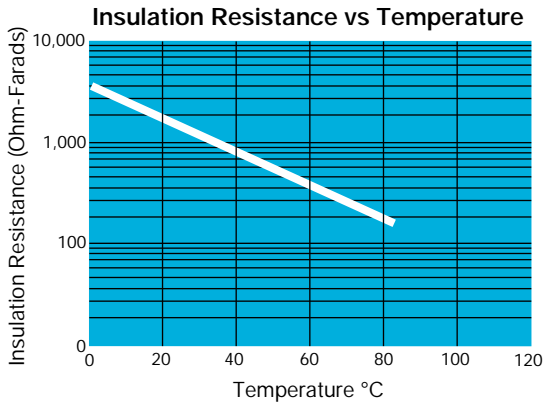
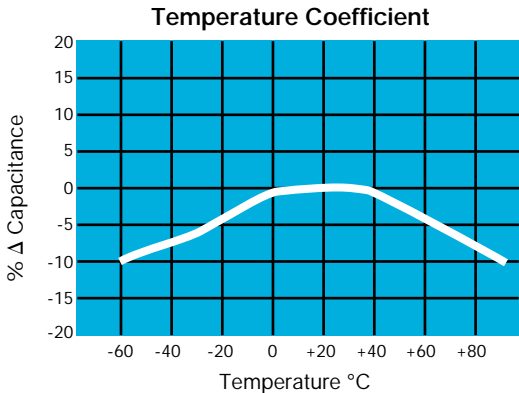

# X5R Dielectric

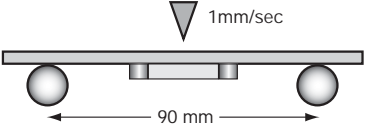

## Specifications and Test Methods

Parameter/Test		X5R Specification Limits	Measuring Conditions	
Operating Temperature Range		-55°C to +85°C	Temperature Cycle Chamber	
Capacitance		Within specified tolerance	Freq.: 1.0 kHz ± 10% Voltage: 1.0Vrms ± .2V For Cap > 10 µF, 0.5Vrms @ 120Hz	
Dissipation Factor		≤ 2.5% for ≥ 50V DC rating ≤ 3.0% for 25V DC rating ≤ 3.5% for 16V DC rating ≤ 5.0% for ≤ 10V DC rating		
Insulation Resistance		100,000MΩ or 500MΩ - µF, whichever is less	Charge device with rated voltage for 120 ± 5 secs @ room temp/humidity	
Dielectric Strength		No breakdown or visual defects	Charge device with 300% of rated voltage for 1-5 seconds, w/charge and discharge current limited to 50 mA (max)	
Resistance to Flexure Stresses	Appearance	No defects	Deflection: 2mm Test Time: 30 seconds 	
	Capacitance Variation	≤ ±12%		
	Dissipation Factor	Meets Initial Values (As Above)		
	Insulation Resistance	≥ Initial Value x 0.3		
Solderability		≥ 95% of each terminal should be covered with fresh solder	Dip device in eutectic solder at 230 ± 5°C for 5.0 ± 0.5 seconds	
Resistance to Solder Heat	Appearance	No defects, <25% leaching of either end terminal	Dip device in eutectic solder at 260°C for 60 seconds. Store at room temperature for 24 ± 2 hours before measuring electrical properties.	
	Capacitance Variation	≤ ±7.5%		
	Dissipation Factor	Meets Initial Values (As Above)		
	Insulation Resistance	Meets Initial Values (As Above)		
	Dielectric Strength	Meets Initial Values (As Above)		
Thermal Shock	Appearance	No visual defects	Step 1: -55°C ± 2°	30 ± 3 minutes
	Capacitance Variation	≤ ±7.5%	Step 2: Room Temp	≤ 3 minutes
	Dissipation Factor	Meets Initial Values (As Above)	Step 3: +85°C ± 2°	30 ± 3 minutes
	Insulation Resistance	Meets Initial Values (As Above)	Step 4: Room Temp	≤ 3 minutes
	Dielectric Strength	Meets Initial Values (As Above)	Repeat for 5 cycles and measure after 24 ± 2 hours at room temperature	
Load Life	Appearance	No visual defects	Charge device with 1.5X rated voltage in test chamber set at 85°C ± 2°C for 1000 hours (+48, -0). Note: Contact factory for specific high CV devices that are tested at 1.5X rated voltage.  Remove from test chamber and stabilize at room temperature for 24 ± 2 hours before measuring.	
	Capacitance Variation	≤ ±12.5%		
	Dissipation Factor	≤ Initial Value x 2.0 (See Above)		
	Insulation Resistance	≥ Initial Value x 0.3 (See Above)		
	Dielectric Strength	Meets Initial Values (As Above)		
Load Humidity	Appearance	No visual defects	Store in a test chamber set at 85°C ± 2°C/ 85% ± 5% relative humidity for 1000 hours (+48, -0) with rated voltage applied.  Remove from chamber and stabilize at room temperature and humidity for 24 ± 2 hours before measuring.	
	Capacitance Variation	≤ ±12.5%		
	Dissipation Factor	≤ Initial Value x 2.0 (See Above)		
	Insulation Resistance	≥ Initial Value x 0.3 (See Above)		
	Dielectric Strength	Meets Initial Values (As Above)		

# X5R Dielectric

## Capacitance Range



PREFERRED SIZES ARE SHADED

SIZE	0201			0402			0603				0805											
Soldering	Reflow Only			Reflow Only			Reflow Only				Reflow/Wave											
Packaging	All Paper			All Paper			All Paper				Paper/Embossed											
(L) Length	MM	0.60 ± 0.03 (0.024 ± 0.001)			1.00 ± 0.10 (0.040 ± 0.004)			1.60 ± 0.15 (0.063 ± 0.006)				2.01 ± 0.20 (0.079 ± 0.008)										
(W) Width	MM	0.30 ± 0.03 (0.011 ± 0.001)			0.50 ± 0.10 (0.020 ± 0.004)			0.81 ± 0.15 (0.032 ± 0.006)				1.25 ± 0.20 (0.049 ± 0.008)										
(t) Terminal	MM	0.15 ± 0.05 (0.006 ± 0.002)			0.25 ± 0.15 (0.010 ± 0.006)			0.35 ± 0.15 (0.014 ± 0.006)				0.50 ± 0.25 (0.020 ± 0.010)										
WVDC		10	16	25	4	6.3	10	16	25	4	6.3	10	16	25	35	6.3	10	16	25	35	50	
Cap (pF)	100			A																		
	150			A																		
	220			A																		
	330			A																		
	470			A																		
	680			A																		
	1000			A																		
	1500		A																			
	2200	A	A																			
	3300	A																				
	4700	A																				
	6800	A																				
Cap (µF)	0.010																					
	0.015																					
	0.022																					
	0.033																					
	0.047																					
	0.068																					
	0.10																					
	0.15																					
	0.22																					
	0.33																					
	0.47																					
	0.68																					
	1.0																					
	1.5																					
	2.2																					
	3.3																					
	4.7																					
	6.8																					
	10																					
	22																					
	47																					
	100																					
WVDC		10	16	25	4	6.3	10	16	25	4	6.3	10	16	25	35	6.3	10	16	25	35	50	

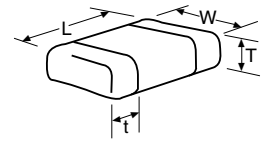

Letter	A	C	E	G	J	K	M	N	P	Q	X	Y	Z
Max. Thickness	0.33 (0.013)	0.56 (0.022)	0.71 (0.028)	0.86 (0.034)	0.94 (0.037)	1.02 (0.040)	1.27 (0.050)	1.40 (0.055)	1.52 (0.060)	1.78 (0.070)	2.29 (0.090)	2.54 (0.100)	2.79 (0.110)
	PAPER					EMBOSSSED							

# X5R Dielectric

## Capacitance Range



PREFERRED SIZES ARE SHADED

SIZE		1206					1210					1812				
Soldering		Reflow/Wave					Reflow Only					Reflow Only				
Packaging		Paper/Embossed					Paper/Embossed					All Embossed				
(L) Length	MM (in.)	3.20 ± 0.20 (0.126 ± 0.008)					3.20 ± 0.20 (0.126 ± 0.008)					4.50 ± 0.30 (0.177 ± 0.012)				
(W) Width	MM (in.)	1.60 ± 0.20 (0.063 ± 0.008)					2.50 ± 0.20 (0.098 ± 0.008)					3.20 ± 0.20 (0.126 ± 0.008)				
(t) Terminal	MM (in.)	0.50 ± 0.25 (0.020 ± 0.010)					0.50 ± 0.25 (0.020 ± 0.010)					0.61 ± 0.36 (0.024 ± 0.014)				
WVDC		6.3	10	16	25	35	6.3	10	16	25	35	6.3	10	25		
Cap (pF)	100															
	150															
	220															
	330															
	470															
	680															
Cap (µF)	0.010															
	0.015															
	0.022															
	0.033															
	0.047															
	0.068															
	0.10															
	0.15															
	0.22															
	0.33															
	0.47															
	0.68															
	1.0															
	1.5															
	2.2															
	3.3															
	4.7															
	6.8															
	10															
	22															
	47															
	100															
WVDC		6.3	10	16	25	35	6.3	10	16	25	35	6.3	10	25		

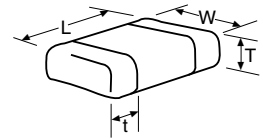

Letter	A	C	E	G	J	K	M	N	P	Q	X	Y	Z
Max. Thickness	0.33 (0.013)	0.56 (0.022)	0.71 (0.028)	0.86 (0.034)	0.94 (0.037)	1.02 (0.040)	1.27 (0.050)	1.40 (0.055)	1.52 (0.060)	1.78 (0.070)	2.29 (0.090)	2.54 (0.100)	2.79 (0.110)
	PAPER					EMBOSSSED							



# Y5V Dielectric

## General Specifications

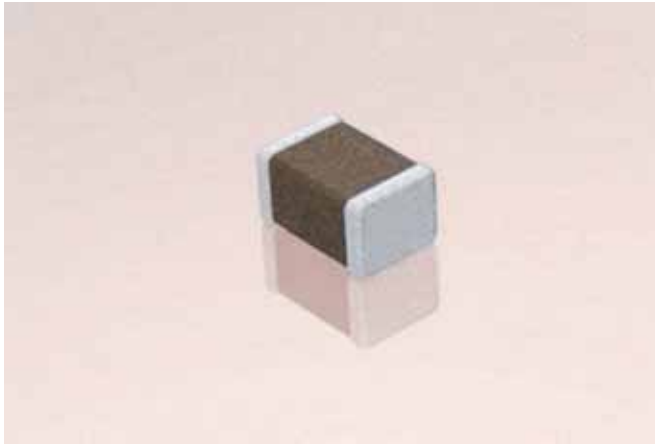

Y5V formulations are for general-purpose use in a limited temperature range. They have a wide temperature characteristic of +22% -82% capacitance change over the operating temperature range of -30°C to +85°C.

These characteristics make Y5V ideal for decoupling applications within limited temperature range.

### PART NUMBER (see page 2 for complete part number explanation)

**0805**

**Size**  
(L" x W")

**3**

**Voltage**  
6.3V = 6  
10V = Z  
16V = Y  
25V = 3  
50V = 5

**G**

**Dielectric**  
Y5V = G

**104**

**Capacitance Code (In pF)**  
2 Sig. Digits + Number of Zeros

**Z**

**Capacitance Tolerance**  
Z = +80 -20%

**A**

**Failure Rate**  
A = Not Applicable

**T**

**Terminations**  
T = Plated Ni and Sn

**2**

**Packaging**  
2 = 7" Reel  
4 = 13" Reel

**A**

**Special Code**  
A = Std. Product

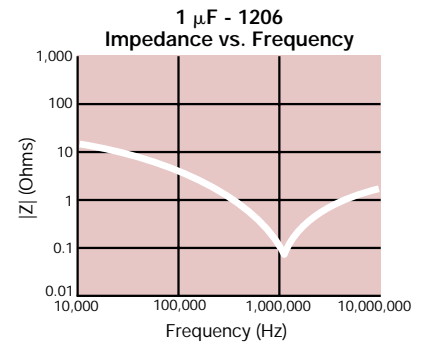
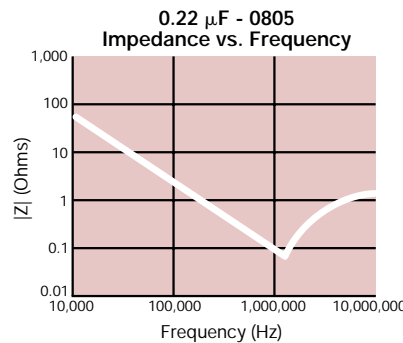
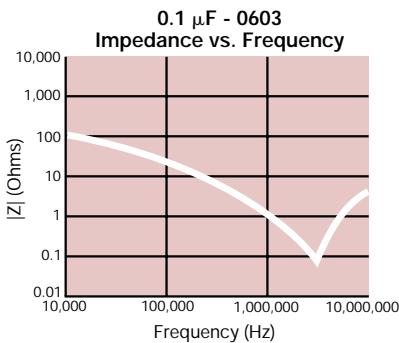
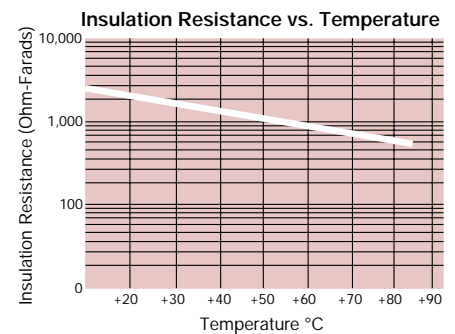
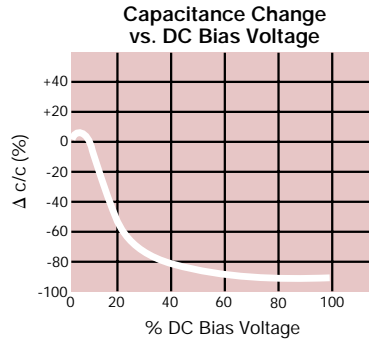
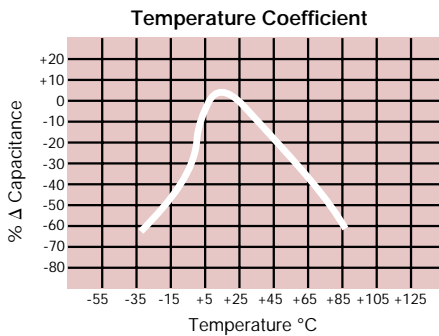



# Y5V Dielectric

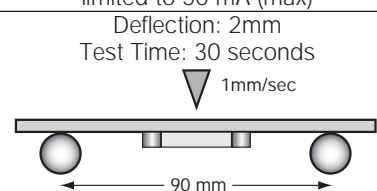

## Specifications and Test Methods

Parameter/Test		Y5V Specification Limits	Measuring Conditions	
Operating Temperature Range		-30°C to +85°C	Temperature Cycle Chamber	
Capacitance		Within specified tolerance	Freq.: 1.0 kHz ± 10% Voltage: 1.0Vrms ± .2V For Cap > 10 µF, 0.5Vrms @ 120Hz	
Dissipation Factor		≤ 5.0% for ≥ 50V DC rating ≤ 7.0% for 25V DC rating ≤ 9.0% for 16V DC rating ≤ 12.5% for ≤ 10V DC rating		
Insulation Resistance		100,000MΩ or 500MΩ - µF, whichever is less	Charge device with rated voltage for 120 ± 5 secs @ room temp/humidity	
Dielectric Strength		No breakdown or visual defects	Charge device with 300% of rated voltage for 1-5 seconds, w/charge and discharge current limited to 50 mA (max)	
Resistance to Flexure Stresses	Appearance	No defects	Deflection: 2mm Test Time: 30 seconds 	
	Capacitance Variation	≤ ±30%		
	Dissipation Factor	Meets Initial Values (As Above)		
	Insulation Resistance	≥ Initial Value x 0.1		
Solderability		≥ 95% of each terminal should be covered with fresh solder	Dip device in eutectic solder at 230 ± 5°C for 5.0 ± 0.5 seconds	
Resistance to Solder Heat	Appearance	No defects, <25% leaching of either end terminal	Dip device in eutectic solder at 260°C for 60 seconds. Store at room temperature for 24 ± 2 hours before measuring electrical properties.	
	Capacitance Variation	≤ ±20%		
	Dissipation Factor	Meets Initial Values (As Above)		
	Insulation Resistance	Meets Initial Values (As Above)		
	Dielectric Strength	Meets Initial Values (As Above)		
Thermal Shock	Appearance	No visual defects	Step 1: -30°C ± 2°	30 ± 3 minutes
	Capacitance Variation	≤ ±20%	Step 2: Room Temp	≤ 3 minutes
	Dissipation Factor	Meets Initial Values (As Above)	Step 3: +85°C ± 2°	30 ± 3 minutes
	Insulation Resistance	Meets Initial Values (As Above)	Step 4: Room Temp	≤ 3 minutes
	Dielectric Strength	Meets Initial Values (As Above)	Repeat for 5 cycles and measure after 24 ± 2 hours at room temperature	
Load Life	Appearance	No visual defects	Charge device with twice rated voltage in test chamber set at 85°C ± 2°C for 1000 hours (+48, -0)  Remove from test chamber and stabilize at room temperature for 24 ± 2 hours before measuring.	
	Capacitance Variation	≤ ±30%		
	Dissipation Factor	≤ Initial Value x 1.5 (See Above)		
	Insulation Resistance	≥ Initial Value x 0.1 (See Above)		
	Dielectric Strength	Meets Initial Values (As Above)		
Load Humidity	Appearance	No visual defects	Store in a test chamber set at 85°C ± 2°C/ 85% ± 5% relative humidity for 1000 hours (+48, -0) with rated voltage applied.  Remove from chamber and stabilize at room temperature and humidity for 24 ± 2 hours before measuring.	
	Capacitance Variation	≤ ±30%		
	Dissipation Factor	≤ Initial Value x 1.5 (See above)		
	Insulation Resistance	≥ Initial Value x 0.1 (See Above)		
	Dielectric Strength	Meets Initial Values (As Above)		

# Y5V Dielectric

## Capacitance Range



PREFERRED SIZES ARE SHADED

SIZE	0201		0402			0603				0805				1206				1210				
Soldering	Reflow Only		Reflow Only			Reflow Only				Reflow/Wave				Reflow/Wave				Reflow Only				
Packaging	All Paper		All Paper			All Paper				Paper/Embossed				Paper/Embossed				Paper/Embossed				
(L) Length	MM (in.)	0.60 ± 0.03 (0.024 ± 0.001)	1.00 ± 0.10 (0.040 ± 0.004)			1.60 ± 0.15 (0.063 ± 0.006)				2.01 ± 0.20 (0.079 ± 0.008)				3.20 ± 0.20 (0.126 ± 0.008)				3.20 ± 0.20 (0.126 ± 0.008)				
(W) Width	MM (in.)	0.30 ± 0.03 (0.011 ± 0.001)	0.50 ± 0.10 (0.020 ± 0.004)			0.81 ± 0.15 (0.032 ± 0.006)				1.25 ± 0.20 (0.049 ± 0.008)				1.60 ± 0.20 (0.063 ± 0.008)				2.50 ± 0.20 (0.098 ± 0.008)				
(t) Terminal	MM (in.)	0.15 ± 0.05 (0.006 ± 0.002)	0.25 ± 0.15 (0.010 ± 0.006)			0.35 ± 0.15 (0.014 ± 0.006)				0.50 ± 0.25 (0.020 ± 0.010)				0.50 ± 0.25 (0.020 ± 0.010)				.50 ± 0.25 (0.020 ± 0.010)				
WVDC		6.3 10	16	25	50	10	16	25	50	10	16	25	50	10	16	25	50	10	16	25	50	
Cap (pF)	820		A																			
	1000		A																			
	2200		A																			
Cap (µF)	4700		A																			
	0.010		A																			
	0.022		A																			
	0.047		A																			
	0.10																					
	0.22																					
	0.47																					
	1.0																					
	2.2																					
	4.7																					
	10.0																					
	22.0																					
	47.0																					
WVDC		6.3 10	16	25	50	10	16	25	50	10	16	25	50	10	16	25	50	10	16	25	50	

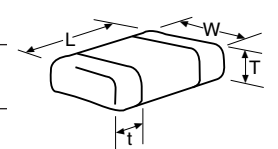

Letter	A	C	E	G	J	K	M	N	P	Q	X	Y	Z
Max. Thickness	0.33 (0.013)	0.56 (0.022)	0.71 (0.028)	0.86 (0.034)	0.94 (0.037)	1.02 (0.040)	1.27 (0.050)	1.40 (0.055)	1.52 (0.060)	1.78 (0.070)	2.29 (0.090)	2.54 (0.100)	2.79 (0.110)
	PAPER					EMBOSSSED							

# MLCC Tin/Lead Termination "B"



## General Specifications

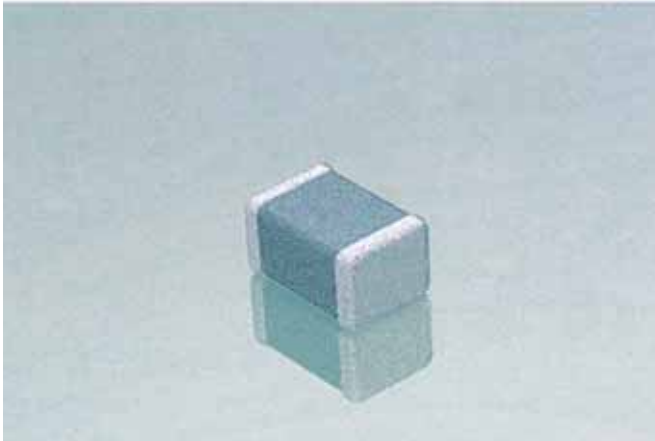

AVX Corporation will support those customers for commercial and military Multilayer Ceramic Capacitors with a termination consisting of 5% minimum lead. This termination is indicated by the use of a "B" in the 12th position of the AVX Catalog Part Number. This fulfills AVX's commitment to providing a full range of products to our customers. AVX has provided in the following pages a full range of values that we are currently offering in this special "B" termination. Please contact the factory if you require additional information on our MLCC Tin/Lead Termination "B" products.

### PART NUMBER (see page 2 for complete part number explanation)

<b>LD05</b>	<b>5</b>	<b>A</b>	<b>101</b>	<b>J</b>	<b>A</b>	<b>B</b>	<b>2</b>	<b>A</b>
<b>Size</b>	<b>Voltage</b>	<b>Dielectric</b>	<b>Capacitance Code (In pF)</b>	<b>Capacitance Tolerance</b>	<b>Failure Rate</b>	<b>Terminations</b>	<b>Packaging</b>	<b>Special Code</b>
LD02 - 0402	6.3V = 6	COG (NPO) = A	2 Sig. Digits +	B = ±.10 pF (<10pF)	A = Not	B = 5% min	2 = 7" Reel	A = Std.
LD03 - 0603	10V = Z	X7R = C	Number of	C = ±.25 pF (<10pF)	Applicable	lead	4 = 13" Reel	Product
LD04 - 0504	16V = Y	X5R = D	Zeros	D = ±.50 pF (<10pF)			7 = Bulk Cass.	
LD05 - 0805	25V = 3			F = ±1% (≥ 10 pF)			9 = Bulk	
LD06 - 1206	50V = 5			G = ±2% (≥ 10 pF)				
LD08 - 1808*	100V = 1			J = ±5%				
LD10 - 1210	200V = 2			K = ±10%				
LD12 - 1812	500V = 7							
LD13 - 1825								
LD14 - 2225								
LD15 - 0204 LICC*								
LD20 - 2220								
LD16 - 0306 LICC								
LD17 - 0508 LICC								
LD18 - 0612 LICC								

\*Contact factory

### ELECTRICAL GRAPHS

NPO	Refer to page 4 for Electrical Graphs
X7R	Refer to page 12 for Electrical Graphs
X7S	Refer to page 16 for Electrical Graphs
X5R	Refer to page 19 for Electrical Graphs
Y5V	Refer to page 23 for Electrical Graphs

# MLCC Tin/Lead Termination "B"



## Capacitance Range (NPO Dielectric)

PREFERRED SIZES ARE SHADED

SIZE		LD02			LD03				LD05					LD06				
Soldering		Reflow Only			Reflow Only				Reflow/Wave					Reflow/Wave				
Packaging		All Paper			All Paper				Paper/Embossed					Paper/Embossed				
(L) Length	MM (in.)	1.00 ± 0.10 (0.040 ± 0.004)			1.60 ± 0.15 (0.063 ± 0.006)				2.01 ± 0.20 (0.079 ± 0.008)					3.20 ± 0.20 (0.126 ± 0.008)				
(W) Width	MM (in.)	0.50 ± 0.10 (0.020 ± 0.004)			0.81 ± 0.15 (0.032 ± 0.006)				1.25 ± 0.20 (0.049 ± 0.008)					1.60 ± 0.20 (0.063 ± 0.008)				
(t) Terminal	MM (in.)	0.25 ± 0.15 (0.010 ± 0.006)			0.35 ± 0.15 (0.014 ± 0.006)				0.50 ± 0.25 (0.020 ± 0.010)					0.50 ± 0.25 (0.020 ± 0.010)				
WVDC		16	25	50	6.3	25	50	100	16	25	50	100	200	16	25	50	100	200
Cap (pF)	0.5	C	C	C	G	G	G	G	E	E	E	E	J	J	J	J	J	J
	1.0	C	C	C	G	G	G	G	E	E	E	E	J	J	J	J	J	J
	1.2	C	C	C	G	G	G	G	E	E	E	E	J	J	J	J	J	J
	1.5	C	C	C	G	G	G	G	E	E	E	E	J	J	J	J	J	J
	1.8	C	C	C	G	G	G	G	E	E	E	E	J	J	J	J	J	J
	2.2	C	C	C	G	G	G	G	E	E	E	E	J	J	J	J	J	J
	2.7	C	C	C	G	G	G	G	E	E	E	E	J	J	J	J	J	J
	3.3	C	C	C	G	G	G	G	E	E	E	E	J	J	J	J	J	J
	3.9	C	C	C	G	G	G	G	E	E	E	E	J	J	J	J	J	J
	4.7	C	C	C	G	G	G	G	E	E	E	E	J	J	J	J	J	J
	5.6	C	C	C	G	G	G	G	E	E	E	E	J	J	J	J	J	J
	6.8	C	C	C	G	G	G	G	E	E	E	E	J	J	J	J	J	J
	8.2	C	C	C	G	G	G	G	E	E	E	E	J	J	J	J	J	J
	10	C	C	C	G	G	G	G	E	E	E	E	J	J	J	J	J	J
	12	C	C	C	G	G	G	G	E	E	E	E	J	J	J	J	J	J
	15	C	C	C	G	G	G	G	E	E	E	E	J	J	J	J	J	J
	18	C	C	C	G	G	G	G	E	E	E	E	J	J	J	J	J	J
	22	C	C	C	G	G	G	G	E	E	E	E	J	J	J	J	J	J
	27	C	C	C	G	G	G	G	E	E	E	E	J	J	J	J	J	J
	33	C	C	C	G	G	G	G	E	E	E	E	J	J	J	J	J	J
	39	C	C	C	G	G	G	G	E	E	E	E	J	J	J	J	J	J
	47	C	C	C	G	G	G	G	E	E	E	E	J	J	J	J	J	J
	56	C	C	C	G	G	G	G	E	E	E	E	J	J	J	J	J	J
	68	C	C	C	G	G	G	G	E	E	E	E	J	J	J	J	J	J
	82	C	C	C	G	G	G	G	E	E	E	E	J	J	J	J	J	J
	100	C	C	C	G	G	G	G	E	E	E	E	J	J	J	J	J	J
	120	C	C	C	G	G	G	G	E	E	E	E	J	J	J	J	J	J
	150	C	C	C	G	G	G	G	E	E	E	E	J	J	J	J	J	J
	180	C	C	C	G	G	G	G	E	E	E	E	J	J	J	J	J	J
	220	C	C	C	G	G	G	G	E	E	E	E	J	J	J	J	J	J
	270	C			G	G	G	G	E	E	E	E	J	M	J	J	J	J
	330	C			G	G	G	G	E	E	E	E	J	M	J	J	J	J
	390				G	G	G		J	J	J	J	M	J	J	J	J	J
	470				G	G	G		J	J	J	J	M	J	J	J	J	J
	560				G	G	G		J	J	J	J		J	J	J	J	J
	680				G	G	G		J	J	J	J		J	J	J	J	J
	820				G	G	G		J	J	J	J		J	J	J	J	M
	1000				G	G	G		J	J	J	J		J	J	J	J	Q
	1200								J	J	J	J		J	J	J	J	Q
	1500								J	J	J	J		J	J	J	M	Q
	1800								J	J	J			J	J	M	M	
	2200								J	J	M			J	J	M	P	
	2700								J	J	M			J	J	M	P	
	3300								N	N	M			J	J	M	P	
	3900								N	N	M			J	J	M	P	
	4700								N	N				J	J	M	P	
	5600								N	N				J	J	M		
	6800								N	N				M	M			
	8200								N	N				M	M			
Cap (µF)	0.010								N					M	M			
	0.012													M	M			
	0.015													M	M			
	0.018																	
	0.022																	
	0.027																	
	0.033																	
	0.039																	
	0.047																	
	0.068																	
	0.082																	
	0.10																	
WVDC		16	25	50	6.3	25	50	100	16	25	50	100	200	16	25	50	100	200
SIZE		0402			0603				0805					1206				

Letter	A	C	E	G	J	K	M	N	P	Q	X	Y	Z
Max. Thickness	0.33 (0.013)	0.56 (0.022)	0.71 (0.028)	0.86 (0.034)	0.94 (0.037)	1.02 (0.040)	1.27 (0.050)	1.40 (0.055)	1.52 (0.060)	1.78 (0.070)	2.29 (0.090)	2.54 (0.100)	2.79 (0.110)
	PAPER					EMBOSSSED							

# MLCC Tin/Lead Termination "B"



## Capacitance Range (NPO Dielectric)

PREFERRED SIZES ARE SHADED

SIZE		LD10				LD12				LD13			LD20			LD14		
Soldering		Reflow/Wave				Reflow Only				Reflow Only			Reflow Only			Reflow Only		
Packaging		Paper/Embossed				All Embossed				All Embossed			All Embossed			All Embossed		
(L) Length	MM	3.20 ± 0.20				4.50 ± 0.30				4.50 ± 0.30			5.70 ± 0.40			5.72 ± 0.25		
	(in.)	(0.126 ± 0.008)				(0.177 ± 0.012)				(0.177 ± 0.012)			(0.225 ± 0.016)			(0.225 ± 0.010)		
(W) Width	MM	2.50 ± 0.20				3.20 ± 0.20				6.40 ± 0.40			5.00 ± 0.40			6.35 ± 0.25		
	(in.)	(0.098 ± 0.008)				(0.126 ± 0.008)				(0.252 ± 0.016)			(0.197 ± 0.016)			(0.250 ± 0.010)		
(t) Terminal	MM	0.50 ± 0.25				0.61 ± 0.36				0.61 ± 0.36			0.64 ± 0.39			0.64 ± 0.39		
	(in.)	(0.020 ± 0.010)				(0.024 ± 0.014)				(0.024 ± 0.014)			(0.025 ± 0.015)			(0.025 ± 0.015)		
WVDC		25	50	100	200	25	50	100	200	50	100	200	50	100	200	50	100	200
Cap (pF)	0.5																	
	1.0																	
	1.2																	
	1.5																	
	1.8																	
	2.2																	
	2.7																	
	3.3																	
	3.9																	
	4.7																	
	5.6																	
	6.8																	
	8.2																	
	10																	
	12																	
	15																	
	18																	
	22																	
	27																	
	33																	
	39																	
	47																	
	56																	
	68																	
	82																	
	100																	
	120																	
	150																	
	180																	
	220																	
	270																	
	330																	
	390																	
	470																	
	560	J	J	J	J													
	680	J	J	J	J													
	820	J	J	J	J													
	1000	J	J	J	J	K	K	K	K	M	M	M	X	X	X	P	P	P
	1200	J	J	J	M	K	K	K	K	M	M	M	X	X	X	P	P	P
	1500	J	J	J	M	K	K	K	K	M	M	M	X	X	X	P	P	P
	1800	J	J	J	M	K	K	K	K	M	M	M	X	X	X	P	P	P
	2200	J	J	M	Q	K	K	K	K	M	M	M				P	P	P
	2700	J	J	M	Q	K	K	K	P	M	M	M				P	P	P
	3300	J	J	M		K	K	K	P	M	M	M				P	P	P
	3900	J	J	M		K	K	K	P	M	M	M				P	P	P
	4700	J	J	M		K	K	K	P	M	M	M				P	P	P
	5600	J	J	M		K	M	M	P	M	M	M				P	P	P
	6800	J	J			K	M	M	X	M	M	M				P	P	P
	8200	J	J			K	P	X	X	M	M					P	P	P
Cap (µF)	0.010	N	N			K	P	X	X	M	M					P	P	P
	0.012	N	N			K	P			M	M					P	P	P
	0.015					M	P			P	M					P	P	Y
	0.018					M	P			P	M					P	P	Y
	0.022					M	P			P						P	Y	Y
	0.027					M										P	Y	Y
	0.033					M										P	Y	Z
	0.039															P	Y	Z
	0.047															P		
	0.068															P		
	0.082																	
	0.10																	
WVDC		25	50	100	200	25	50	100	200	50	100	200	50	100	200	50	100	200
SIZE		1210				1812				1825			2220			2225		
Letter		A	C	E	G	J	K	M	N	P	Q	X	Y	Z				
Max. Thickness		0.33 (0.013)	0.56 (0.022)	0.71 (0.028)	0.86 (0.034)	0.94 (0.037)	1.02 (0.040)	1.27 (0.050)	1.40 (0.055)	1.52 (0.060)	1.78 (0.070)	2.29 (0.090)	2.54 (0.100)	2.79 (0.110)				
		PAPER					EMBOSSSED											

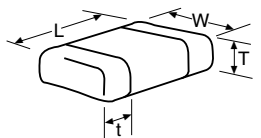



# MLCC Tin/Lead Termination "B"



## Capacitance Range (X7R Dielectric)

PREFERRED SIZES ARE SHADED

SIZE	LD10					LD12		LD13		LD14		
	Reflow/Wave					Reflow Only		Reflow Only		Reflow Only		
Packaging	Paper/Embossed					All Embossed		All Embossed		All Embossed		
(L) Length	MM	3.20 ± 0.20					4.50 ± 0.30		4.50 ± 0.30		5.72 ± 0.25	
(in.)		(0.126 ± 0.008)					(0.177 ± 0.012)		(0.177 ± 0.012)		(0.225 ± 0.010)	
(W) Width	MM	2.50 ± 0.20					3.20 ± 0.20		6.40 ± 0.40		6.35 ± 0.25	
(in.)		(0.098 ± 0.008)					(0.126 ± 0.008)		(0.252 ± 0.016)		(0.250 ± 0.010)	
(t) Terminal	MM	0.50 ± 0.25					0.61 ± 0.36		0.61 ± 0.36		0.64 ± 0.39	
(in.)		(0.020 ± 0.010)					(0.024 ± 0.014)		(0.024 ± 0.014)		(0.025 ± 0.015)	
WVDC	10	16	25	50	100	50	100	50	100	50	100	
Cap (pF)	100											
	120											
	150											
	180											
	220											
	270											
	330											
	390											
	470											
	560											
	680											
	820											
	1000	J	J	J	J	J						
	1200	J	J	J	J	J						
	1500	J	J	J	J	J						
	1800	J	J	J	J	J						
	2200	J	J	J	J	J						
	2700	J	J	J	J	J						
	3300	J	J	J	J	J						
	3900	J	J	J	J	J						
	4700	J	J	J	J	J						
	5600	J	J	J	J	J						
	6800	J	J	J	J	J						
	8200	J	J	J	J	J						
Cap (µF)	0.010	J	J	J	J	J	K	K	M	M	M	M
	0.012	J	J	J	J	J	K	K	M	M	M	M
	0.015	J	J	J	J	J	K	K	M	M	M	M
	0.018	J	J	J	J	J	K	K	M	M	M	M
	0.022	J	J	J	J	J	K	K	M	M	M	M
	0.027	J	J	J	J	J	K	K	M	M	M	M
	0.033	J	J	J	J	J	K	K	M	M	M	M
	0.039	J	J	J	J	J	K	K	M	M	M	M
	0.047	J	J	J	J	J	K	K	M	M	M	M
	0.056	J	J	J	J	J	K	K	M	M	M	M
	0.068	J	J	J	J	J	K	K	M	M	M	M
	0.082	J	J	J	J	J	K	K	M	M	M	M
	0.10	J	J	J	J	J	K	K	M	M	M	M
	0.12	J	J	J	J	M	K	K	M	M	M	M
	0.15	J	J	J	J	M	K	K	M	M	M	M
	0.18	J	J	J	J	P	K	K	M	M	M	M
	0.22	J	J	J	J	P	K	K	M	M	M	M
	0.27	J	J	J	J		K	M	M	M	M	M
	0.33	J	J	J	J		K	M	M	M	M	M
	0.47	M	M	M	M		K	P	M	M	M	M
	0.56	M	M	M			M	Q	M		M	M
	0.68	M	M	P			M	Q	M		M	M
	0.82	M	M	P			M		M		M	M
	1.0	N	N				M		M		M	M
	1.2											
	1.5	N	N						M		M	P
	1.8											
	2.2										M	
	3.3											
	4.7											
	10											
	22											
	47											
	100											
WVDC	10	16	25	50	100	50	100	50	100	50	100	
SIZE	1210					1812		1825		2225		

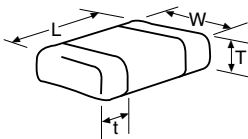

Letter	A	C	E	G	J	K	M	N	P	Q	X	Y	Z
Max. Thickness	0.33 (0.013)	0.56 (0.022)	0.71 (0.028)	0.86 (0.034)	0.94 (0.037)	1.02 (0.040)	1.27 (0.050)	1.40 (0.055)	1.52 (0.060)	1.78 (0.070)	2.29 (0.090)	2.54 (0.100)	2.79 (0.110)
	PAPER					EMBOSSSED							



# MLCC Tin/Lead Termination "B"



## Capacitance Range (X5R Dielectric)

PREFERRED SIZES ARE SHADED

SIZE	LD02		LD03		LD05		LD06			LD10
	Reflow Only		Reflow Only		Reflow/Wave		Reflow/Wave			Reflow/Wave
Soldering	All Paper		All Paper		Paper/Embossed		Paper/Embossed			Paper/Embossed
(L) Length	MM 1.00 ± 0.10 (0.040 ± 0.004)		MM 1.60 ± 0.15 (0.063 ± 0.006)		MM 2.01 ± 0.20 (0.079 ± 0.008)		MM 3.20 ± 0.20 (0.126 ± 0.008)			MM 3.20 ± 0.20 (0.126 ± 0.008)
(W) Width	MM 0.50 ± 0.10 (0.020 ± 0.004)		MM 0.81 ± 0.15 (0.032 ± 0.006)		MM 1.25 ± 0.20 (0.049 ± 0.008)		MM 1.60 ± 0.20 (0.063 ± 0.008)			MM 2.50 ± 0.20 (0.098 ± 0.008)
(t) Terminal	MM 0.25 ± 0.15 (0.010 ± 0.006)		MM 0.35 ± 0.15 (0.014 ± 0.006)		MM 0.50 ± 0.25 (0.020 ± 0.010)		MM 0.50 ± 0.25 (0.020 ± 0.010)			MM 0.50 ± 0.25 (0.020 ± 0.010)
WVDC	6.3	10	6.3	25	10	16	10	16	25	16
Cap (pF)	100									
	150									
	220									
	330									
	470									
	680									
	1000									
	1200									
	1500									
	1800									
	2200									
	2700									
	3300									
	3900									
	4700									
	5600									
	6800									
	8200									
Cap (µF)	0.010									
	0.012									
	0.015									
	0.018									
	0.022									
	0.027									
	0.033									
	0.039									
	0.047	C								
	0.056	C								
	0.068	C		G						
	0.082									
	0.10	C	C		G					
	0.12									
	0.15									
	0.18									
	0.22									
	0.27			G						
	0.33			G			N			
	0.47			G			N			
	0.56									
	0.68			G			N		M	
	0.82									
	1.0			G		N	N		Q	
	1.2									
	1.5					N		Q		
	1.8									
	2.2					N		Q		
	3.3							Q		
	4.7							Q		Q
	6.8									Q
	10									
	22									
	47									
	100									
WVDC	6.3	10	6.3	25	10	16				
SIZE	0402		0603		0805		1206			1210

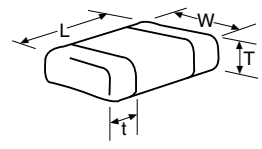

Letter	A	C	E	G	J	K	M	N	P	Q	X	Y	Z
Max. Thickness	0.33 (0.013)	0.56 (0.022)	0.71 (0.028)	0.86 (0.034)	0.94 (0.037)	1.02 (0.040)	1.27 (0.050)	1.40 (0.055)	1.52 (0.060)	1.78 (0.070)	2.29 (0.090)	2.54 (0.100)	2.79 (0.110)
	PAPER					EMBOSS							





## Automotive

### GENERAL DESCRIPTION

AVX Corporation has supported the Automotive Industry requirements for Multilayer Ceramic Capacitors consistently for more than 10 years. Products have been developed and tested specifically for automotive applications and all manufacturing facilities are QS9000 and VDA 6.4 approved.

As part of our sustained investment in capacity and state of the art technology, we are now transitioning from the established Pd/Ag electrode system to a Base Metal Electrode system (BME).

AVX is using AECQ200 as the qualification vehicle for this transition. A detailed qualification package is available on request and contains results on a range of part numbers including:

- X7R dielectric components containing BME electrode and copper terminations with a Ni/Sn plated overcoat.
- X7R dielectric components BME electrode and soft terminations with a Ni/Sn plated overcoat.
- NP0 dielectric components containing Pd/Ag electrode and silver termination with a Ni/Sn plated overcoat.

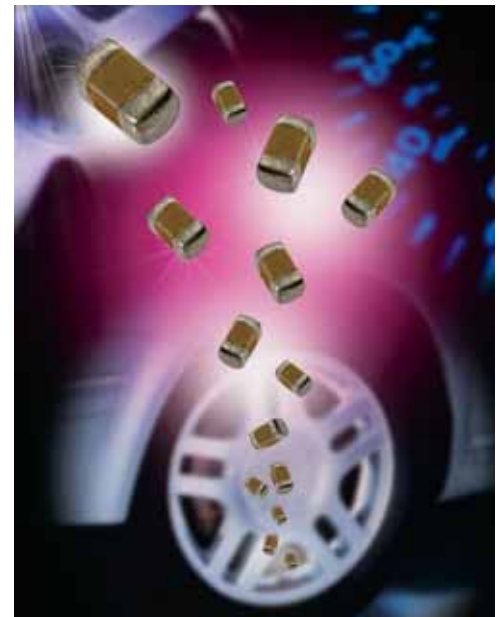

### HOW TO ORDER

<b>0805</b>	<b>5</b>	<b>C</b>	<b>104</b>	<b>K</b>	<b>4</b>	<b>T</b>	<b>2</b>	<b>A</b>
<b>Size</b>	<b>Voltage</b>	<b>Dielectric</b>	<b>Capacitance Code (In pF)</b>	<b>Capacitance Tolerance</b>	<b>Failure Rate</b>	<b>Terminations</b>	<b>Packaging</b>	<b>Special Code</b>
0603 0805 1206 1210 1812	6.3V = 6 10V = Z 16V = Y 25V = 3 50V = 5 100V = 1 200V = 2	NP0 = A X7R = C	2 Significant Digits + Number of Zeros e.g. 10µF = 106	J = ±5% K = ±10% M = ±20%	4 = Automotive	T = Plated Ni and Sn Z = Soft Termination U = Conductive Epoxy	2 = 7" Reel 4 = 13" Reel	A = Std. Product

### COMMERCIAL VS AUTOMOTIVE MLCC PROCESS COMPARISON

	Commercial	Automotive
<b>Administrative</b>	Standard Part Numbers. No restriction on who purchases these parts.	Specific Automotive Part Number. Used to control supply of product to Automotive customers.
<b>Design</b>	Minimum ceramic thickness of 0.020"	Minimum Ceramic thickness of 0.029" (0.74mm) on all X7R product.
<b>Dicing</b>	Side & End Margins = 0.003" min	Side & End Margins = 0.004" min Cover Layers = 0.005" min
<b>Lot Qualification (Destructive Physical Analysis - DPA)</b>	As per EIA RS469	Increased sample plan – stricter criteria.
<b>Visual/Cosmetic Quality</b>	Standard process and inspection	100% inspection
<b>Application Robustness</b>	Standard sampling for accelerated wave solder on X7R dielectrics	Increased sampling for accelerated wave solder on X7R and NP0 followed by lot by lot reliability testing.

All Tests have Accept/Reject Criteria 0/1

# Automotive MLCC

## NP0/X7R Dielectric



### SOFT TERMINATION FEATURES

a) Bend Test

The capacitor is soldered to the PC Board as shown:

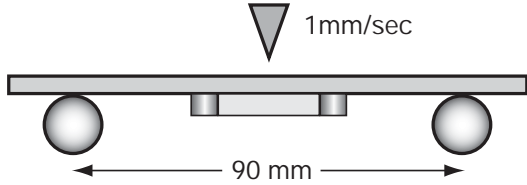

b) Temperature Cycle testing

“Soft Termination” has the ability to withstand at least 1000 cycles between -55°C and +125°C

Typical bend test results are shown below:

Style	Conventional Term	Soft Term
0603	>2mm	>5
0805	>2mm	>5
1206	>2mm	>5

### ELECTRODE AND TERMINATION OPTIONS

#### NP0 DIELECTRIC

**NP0 Ag/Pd Electrode  
Nickel Barrier Termination  
PCB Application**

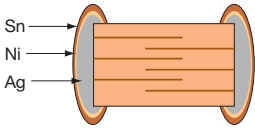

Figure 1 Termination Code T

#### X7R DIELECTRIC

**X7R Dielectric  
PCB Application**

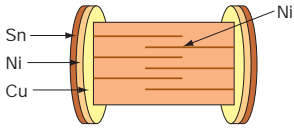

Figure 2 Termination Code T

**X7R Nickel Electrode  
Soft Termination  
PCB Application**

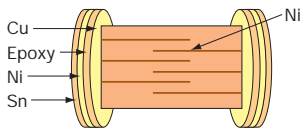

Figure 3 Termination Code Z

**Conductive Epoxy Termination  
Hybrid Application**

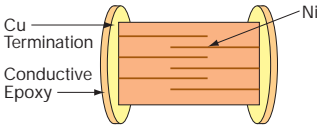

Figure 4 Termination Code U



# NP0 Automotive

## Capacitance Range (Ni Barrier Termination)



	0603			0805			1206			1210				1812	
	25V	50V	100V	25V	50V	100V	25V	50V	100V	25V	50V	100V	200V	50V	100V
R47	G	G	G	J	J	J	J	J	J						
R51	G	G	G	J	J	J	J	J	J						
R56	G	G	G	J	J	J	J	J	J						
R62	G	G	G	J	J	J	J	J	J						
R68	G	G	G	J	J	J	J	J	J						
R75	G	G	G	J	J	J	J	J	J						
R82	G	G	G	J	J	J	J	J	J						
R91	G	G	G	J	J	J	J	J	J						
1R0	G	G	G	J	J	J	J	J	J						
1R2	G	G	G	J	J	J	J	J	J						
1R5	G	G	G	J	J	J	J	J	J						
1R8	G	G	G	J	J	J	J	J	J						
2R0	G	G	G	J	J	J	J	J	J						
2R2	G	G	G	J	J	J	J	J	J						
2R4	G	G	G	J	J	J	J	J	J						
2R7	G	G	G	J	J	J	J	J	J						
3R0	G	G	G	J	J	J	J	J	J						
3R3	G	G	G	J	J	J	J	J	J						
3R6	G	G	G	J	J	J	J	J	J						
3R9	G	G	G	J	J	J	J	J	J						
4R3	G	G	G	J	J	J	J	J	J						
4R7	G	G	G	J	J	J	J	J	J						
5R1	G	G	G	J	J	J	J	J	J						
5R6	G	G	G	J	J	J	J	J	J						
6R2	G	G	G	J	J	J	J	J	J						
6R8	G	G	G	J	J	J	J	J	J						
7R5	G	G	G	J	J	J	J	J	J						
8R2	G	G	G	J	J	J	J	J	J						
9R1	G	G	G	J	J	J	J	J	J						
100	G	G	G	J	J	J	J	J	J						
120	G	G	G	J	J	J	J	J	J						
150	G	G	G	J	J	J	J	J	J						
180	G	G	G	J	J	J	J	J	J						
220	G	G	G	J	J	J	J	J	J						
270	G	G	G	J	J	J	J	J	J						
330	G	G	G	J	J	J	J	J	J						
390	G	G	G	J	J	J	J	J	J						
470	G	G	G	J	J	J	J	J	J						
510	G	G	G	J	J	J	J	J	J						
560	G	G	G	J	J	J	J	J	J						
680	G	G	G	J	J	J	J	J	J						
820	G	G	G	J	J	J	J	J	J						
101	G	G	G	J	J	J	J	J	J						
121	G	G	G	J	J	J	J	J	J						
151	G	G	G	J	J	J	J	J	J						
181	G	G	G	J	J	J	J	J	J						
221	G	G	G	J	J	J	J	J	J						
271	G	G	G	J	J	J	J	J	J						
331	G	G	G	J	J	J	J	J	J						
391	G	G		J	J	J	J	J	J						
471	G	G		J	J	J	J	J	J						
561	G			J	J	J	J	J	J						
681				J	J	J	J	J	J						
821				J	J	J	J	J	J						
102				J	J	J	J	J	J	J	J	J	J		
122				J			J	J	J	J	J	M	M		
152				J			J	M	M	J	J	M	M		
182				J			J	M	M	J	J	M	M		
222				M			J	M	M	J	J	M	M		
272				M			J	M	Q	J	J	M			
332							J	M	Q	J	J	M			
392							J	M		J	J	P		K	K
472							J	M		J	M	P		K	K
562							M			M					
682							M			M					
822							M			M					
103							M			M					

Letter	A	C	E	G	J	K	M	N	P	Q	X	Y	Z
Max. Thickness	0.33 (0.013)	0.56 (0.022)	0.71 (0.028)	0.86 (0.034)	0.94 (0.037)	1.02 (0.040)	1.27 (0.050)	1.40 (0.055)	1.52 (0.060)	1.78 (0.070)	2.29 (0.090)	2.54 (0.100)	2.79 (0.110)
	PAPER					EMBOSSSED							



# BME X7R Automotive



## Capacitance Range (Ni Barrier Termination)

	0603					0805					1206					1210					1812				
	16V	25V	50V	100V	200V	16V	25V	50V	100V	200V	16V	25V	50V	100V	200V	16V	25V	50V	100V	200V	16V	25V	50V	100V	200V
101																									
121																									
151																									
181																									
221																									
271	G	G	G	G		J	J	J																	
331	G	G	G	G		J	J	J	J	J															
391	G	G	G	G		J	J	J	J	J															
471	G	G	G	G		J	J	J	J	J															
561	G	G	G	G		J	J	J	J	J															
681	G	G	G	G		J	J	J	J	J															
821	G	G	G	G		J	J	J	J	J															
102	G	G	G	G		J	J	J	J	J	J	J	J	J											
122	G	G	G	G		J	J	J	J	J	J	J	J	J											
152	G	G	G	G		J	J	J	J	J	J	J	J	J											
182	G	G	G	G		J	J	J	J	J	J	J	J	J											
222	G	G	G	G		J	J	J	J	J	J	J	J	J											
272	G	G	G	G		J	J	J	J																
332	G	G	G	G		J	J	J	J																
392	G	G	G	G		J	J	J	J																
472	G	G	G	G		J	J	J	J																
562	G	G	G	G		J	J	J	J																
682	G	G	G	G		J	J	J	J																
822	G	G	G	G		J	J	J	J																
103	G	G	G	G		J	J	J	J																
123	G	G	G			J	J	J	M																
153	G	G	G			J	J	J	M																
183	G	G	G			J	J	J	M																
223	G	G	G			J	J	J	M																
273	G	G	G			J	J	J	M																
333	G	G	G			J	J	J	M																
393	G	G				J	J	J	M																
473	G	G				J	J	J	M																
563	G					J	J	J																	
683	G					J	J	J																	
823	G					J	J	J																	
104	G					J	J	J																	
124						J	J																		
154						M	N																		
184						M	N																		
224						M	N																		
274						N																			
334						N																			
394						N																			
474						N																			
564																									
684																									
824																									
105																									
155																									
	16V	25V	50V	100V	200V	16V	25V	50V	100V	200V	16V	25V	50V	100V	200V	16V	25V	50V	100V	200V	16V	25V	50V	100V	200V

Letter	A	C	E	G	J	K	M	N	P	Q	X	Y	Z
Max. Thickness	0.33 (0.013)	0.56 (0.022)	0.71 (0.028)	0.86 (0.034)	0.94 (0.037)	1.02 (0.040)	1.27 (0.050)	1.40 (0.055)	1.52 (0.060)	1.78 (0.070)	2.29 (0.090)	2.54 (0.100)	2.79 (0.110)
	PAPER					EMBOSSSED							

# MLCC with Soft Termination

## General Specifications

### GENERAL DESCRIPTION

With increased requirements from the automotive industry for additional component robustness, AVX recognized the need to produce a MLCC with enhanced mechanical strength. It was noted that many components may be subject to severe flexing and vibration when used in various under the bonnet automotive applications.

To satisfy the requirement for enhanced mechanical strength, AVX had to find a way of ensuring electrical integrity is maintained whilst external forces are being applied to the component. It was found that the structure of the termination needed to be flexible and after much research and development, a "soft termination" was found. This soft termination is designed to enhance the mechanical flexure and temperature cycling performance of a standard ceramic capacitor with an X7R dielectric. **The industry standard for flexure is 2 mm minimum with Soft Termination. AVX guarantees a minimum flexure of 5 mm, without any internal cracks. Beyond 5mm generally the component will open. The industry standard for temperature cycling is 1000 cycles, AVX guarantees 3000 cycles.**

As well as for automotive applications the Soft Termination will provide Design Engineers with a satisfactory solution when designing PCB's which may be subject to high levels of board flexure.

### PRODUCT ADVANTAGES

- High mechanical performance able to withstand, 5mm bend test guaranteed.
- Open failure mode is apparent when products are overstressed by 5mm.
- Increased temperature cycling performance, 3000 cycles and beyond.
- Flexible termination system.
- Reduction in circuit board flex failures.
- Base metal electrode system.
- Automotive or commercial grade products available.

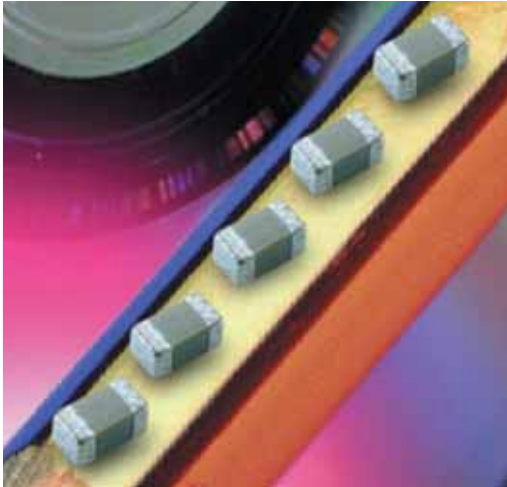

### APPLICATIONS

#### High Flexure Stress Circuit Boards

- e.g. Depanelization: Components near edges of board.

#### Variable Temperature Applications

- Soft termination offers improved reliability performance in applications where there is temperature variation.
- e.g. All kind of engine sensors: Direct connection to battery rail.

#### Automotive Applications

- Improved reliability.
- Excellent mechanical performance and thermo mechanical performance.

### HOW TO ORDER

<b>0805</b>	<b>5</b>	<b>C</b>	<b>104</b>	<b>K</b>	<b>A</b>	<b>Z</b>	<b>2</b>	<b>A</b>
<b>Style</b>	<b>Voltage</b>	<b>Dielectric</b>	<b>Capacitance Code (In pF)</b>	<b>Capacitance Tolerance</b>	<b>Failure Rate</b>	<b>Terminations</b>	<b>Packaging</b>	<b>Special Code</b>
0603 0805 1206 1210 1812	6 = 6.3V Z = 10V Y = 16V 3 = 25V 5 = 50V 1 = 100V 2 = 200V	C = X7R	2 Sig Digits + Number of Zeros e.g., 104 = 100nF	J = ±5% K = ±10% M = ±20%	A=Commercial 4 = Automotive	Z = Soft Termination	2 = 7" reel 4 = 13" reel	A = Std. Product

# MLCC with Soft Termination

## Specifications and Test Methods

### PERFORMANCE TESTING

**AEC-Q200 Qualification:**

- Created by the Automotive Electronics Council
- Specification defining stress test qualification for passive components



**Testing:**

Key tests used to compare soft termination to AEC-Q200 qualification:

- Bend Test
- Temperature Cycle Test

### BOARD BEND TEST PROCEDURE

According to AEC-Q200

Test Procedure as per AEC-Q200:

Sample size: 20 components  
 Span: 90mm Minimum deflection spec: 2 mm

- Components soldered onto FR4 PCB (Figure 1)
- Board connected electrically to the test equipment (Figure 2)

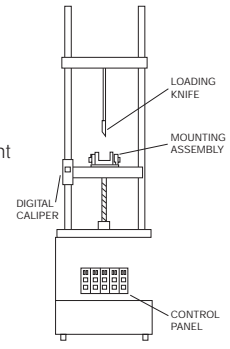

Fig 2 - Board Bend test equipment

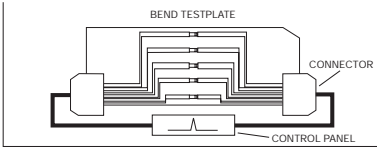
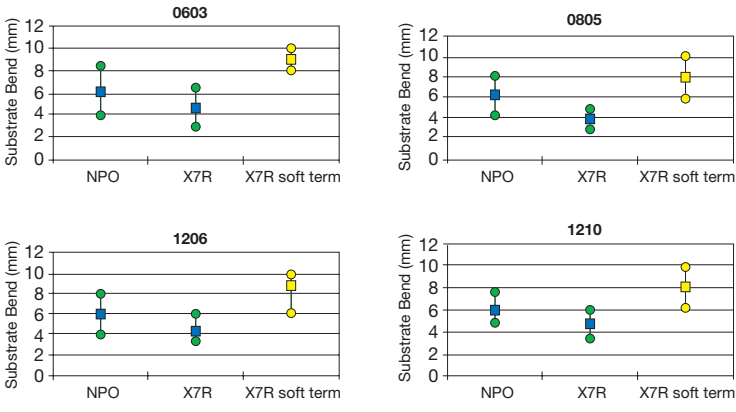

Fig 1 - PCB layout with electrical connections

### BOARD BEND TEST RESULTS

AEC-Q200 Vrs AVX Soft Termination Bend Test



### AVX ENHANCED SOFT TERMINATION BEND TEST PROCEDURE

**Bend Test**

The capacitor is soldered to the printed circuit board as shown and is bent up to 10mm at 1mm per second:

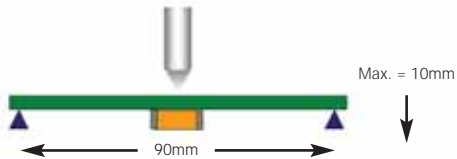

- The board is placed on 2 supports 90mm apart (capacitor side down)
- The row of capacitors is aligned with the load stressing knife



- The load is applied and the deflection where the part starts to crack is recorded (Note: Equipment detects the start of the crack using a highly sensitive current detection circuit)
- The maximum deflection capability is 10mm

### TABLE SUMMARY

Typical bend test results are shown below:

Style	Conventional Termination	Soft Termination
0603	>2mm	>5mm
0805	>2mm	>5mm
1206	>2mm	>5mm

### TEMPERATURE CYCLE TEST PROCEDURE

**Test Procedure as per AEC-Q200:**

The test is conducted to determine the resistance of the component when it is exposed to extremes of alternating high and low temperatures.

- Sample lot size quantity 77 pieces
- TC chamber cycle from -55°C to +125°C for 1000 cycles
- Interim electrical measurements at 250, 500, 1000 cycles
- Measure parameter capacitance dissipation factor, insulation resistance

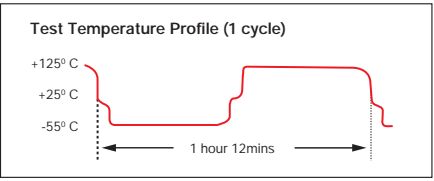

### BEYOND 1000 CYCLES: TEMPERATURE CYCLE TEST RESULTS

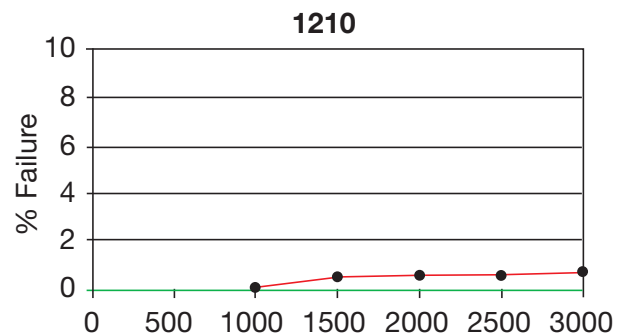
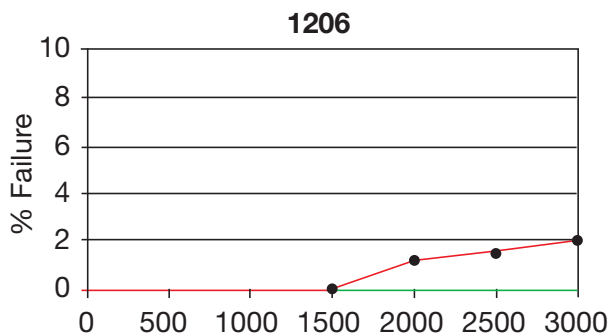
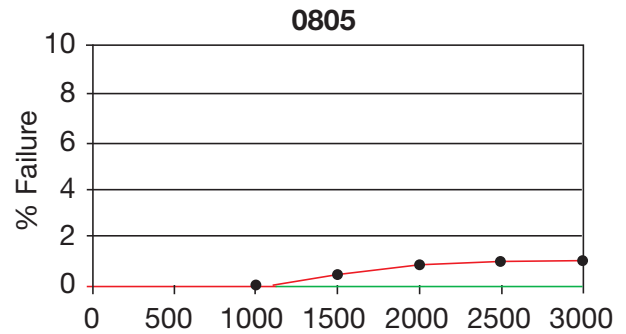
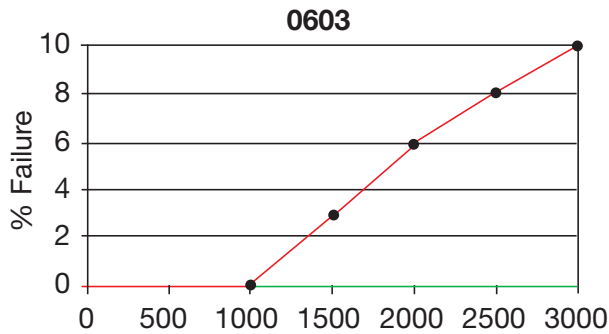

**Soft Term - No Defects up to 3000 cycles**

AEC-Q200 specification states 1000 cycles compared to AVX 3000 temperature cycles.

### SOFT TERMINATION TEST SUMMARY

- Qualified product by using the AEC-Q200 test/specification with the exception of using AVX 3000 temperature cycles (up to +150°C bend test guaranteed greater than 5mm).
- Soft Termination provides improved performance compared to standard termination systems.
- Board bend test improvement by a factor of 2 to 4 times.
- Temperature Cycling:
  - 0% Failure up to 3000 cycles
  - No ESR change up to 3000 cycles

#### WITHOUT SOFT TERMINATION

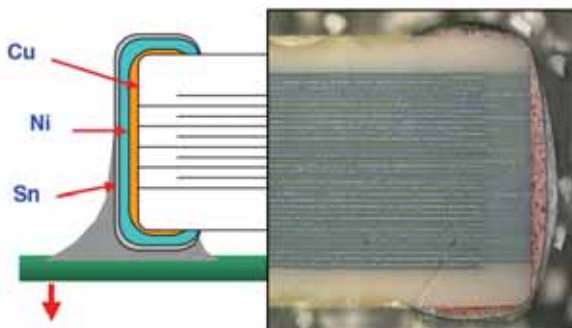

Major fear is of latent board flex failures.

#### WITH SOFT TERMINATION

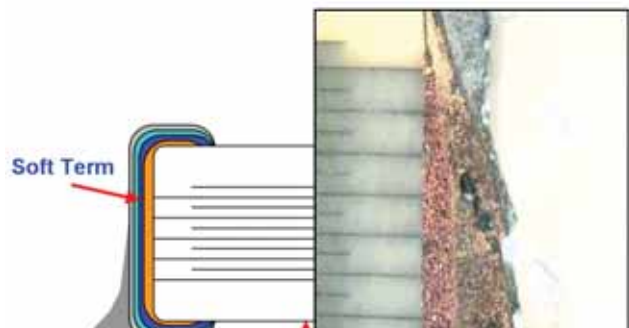

Far superior mechanical performance. Generally open failure mode beyond 5mm flexure.

# MLCC with Soft Termination



## X7R Dielectric Capacitance Range

	0603				0805				1206				1210				1812			
	16V	25V	50V	100V	16V	25V	50V	100V	16V	25V	50V	100V	16V	25V	50V	100V	16V	25V	50V	100V
101																				
121																				
151																				
181																				
221																				
271	J	J	J	J																
331	J	J	J	J	J	J	J	J												
391	J	J	J	J	J	J	J	J												
471	J	J	J	J	J	J	J	J												
561	J	J	J	J	J	J	J	J												
681	J	J	J	J	J	J	J	J												
821	J	J	J	J	J	J	J	J												
102	J	J	J	J	J	J	J	J	J	J	J	J								
122	J	J	J	J	J	J	J	J	J	J	J	J								
152	J	J	J	J	J	J	J	J	J	J	J	J								
182	J	J	J	J	J	J	J	J	J	J	J	J								
222	J	J	J	J	J	J	J	J	J	J	J	J								
272	J	J	J	J	J	J	J	J	J	J	J	J								
332	J	J	J	J	J	J	J	J	J	J	J	J								
392	J	J	J	J	J	J	J	J	J	J	J	J								
472	J	J	J	J	J	J	J	J	J	J	J	J								
562	J	J	J	J	J	J	J	J	J	J	J	J								
682	J	J	J	J	J	J	J	J	J	J	J	J								
822	J	J	J	J	J	J	J	J	J	J	J	J								
103	J	J	J	J	J	J	J	J	J	J	J	J								
123	J	J	J		J	J	J	M	J	J	J	J								
153	J	J	J		J	J	J	M	J	J	J	J								
183	J	J	J		J	J	J	M	J	J	J	J								
223	J	J	J		J	J	J	M	J	J	J	J							K	
273	J	J	J		J	J	J	M	J	J	J	J							K	
333	J	J	J		J	J	J	M	J	J	J	J							K	
393	J	J			J	J	J	M	J	J	J	M							K	
473	J	J			J	J	J	M	J	J	J	M							K	
563	J				J	J	J		J	J	J	M	K	K	K	M	K	K	K	K
683	J				J	J	J		J	J	J	M	K	K	K	M	K	K	K	K
823	J				J	J	J		J	J	J	P	K	K	K	M	K	K	K	K
104	J				J	J	J		J	J	J	Q	K	K	K	P	K	K	K	K
124					J	J			J	J	M		K	K	K		K	K	K	K
154					M	N			J	J	M		K	K	K		K	K	K	M
184					M	N			J	M	M		M	M	M		K	K	K	M
224					M	N			J	M	M		M	M	M		M	M	M	X
274					N				J	M			P	P	P		M	M	M	X
334					N				J	M			P	P	P		M	M	M	X
394					N				M	M			P	P	P		X	X	X	X
474					N				M	M			P	P	P		X	X	X	X
564									M				P				X	X	X	
684									M				P				X	X	X	
824									M				P				X	X	X	
105									M				P				X	X	X	
155													P							
185																				
225																				
	16V	25V	50V	100V	16V	25V	50V	100V	16V	25V	50V	100V	16V	25V	50V	100V	16V	25V	50V	100V
	0603				0805				1206				1210				1812			

Letter	A	C	E	G	J	K	M	N	P	Q	X	Y	Z
Max. Thickness	0.33 (0.013)	0.56 (0.022)	0.71 (0.028)	0.86 (0.034)	0.94 (0.037)	1.02 (0.040)	1.27 (0.050)	1.40 (0.055)	1.52 (0.060)	1.78 (0.070)	2.29 (0.090)	2.54 (0.100)	2.79 (0.110)
	PAPER					EMBOSSSED							

 = Range extension parts



## Capacitor Array (IPC)

### BENEFITS OF USING CAPACITOR ARRAYS

AVX capacitor arrays offer designers the opportunity to lower placement costs, increase assembly line output through lower component count per board and to reduce real estate requirements.

#### Reduced Costs

Placement costs are greatly reduced by effectively placing one device instead of four or two. This results in increased throughput and translates into savings on machine time. Inventory levels are lowered and further savings are made on solder materials, etc.

#### Space Saving

Space savings can be quite dramatic when compared to the use of discrete chip capacitors. As an example, the 0508 4-element array offers a space reduction of >40% vs. 4 x 0402 discrete capacitors and of >70% vs. 4 x 0603 discrete capacitors. (This calculation is dependent on the spacing of the discrete components.)

#### Increased Throughput

Assuming that there are 220 passive components placed in a mobile phone:

A reduction in the passive count to 200 (by replacing discrete components with arrays) results in an increase in throughput of approximately 9%.

A reduction of 40 placements increases throughput by 18%.

For high volume users of cap arrays using the very latest placement equipment capable of placing 10 components per second, the increase in throughput can be very significant and can have the overall effect of reducing the number of placement machines required to mount components:

If 120 million 2-element arrays or 40 million 4-element arrays were placed in a year, the requirement for placement equipment would be reduced by one machine.

During a 20Hr operational day a machine places 720K components. Over a working year of 167 days the machine can place approximately 120 million. If 2-element arrays are mounted instead of discrete components, then the number of placements is reduced by a factor of two and in the scenario where 120 million 2-element arrays are placed there is a saving of one pick and place machine.

Smaller volume users can also benefit from replacing discrete components with arrays. The total number of placements is reduced thus creating spare capacity on placement machines. This in turn generates the opportunity to increase overall production output without further investment in new equipment.

#### W2A (0508) Capacitor Arrays

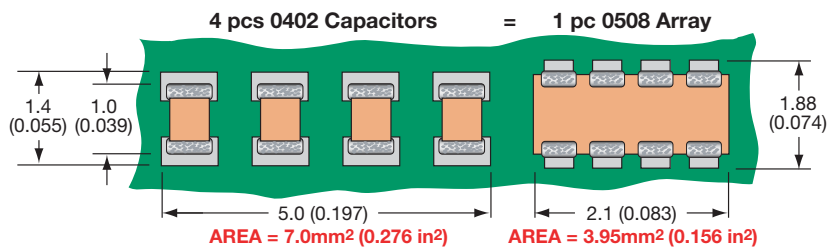

The 0508 4-element capacitor array gives a PCB space saving of over 40% vs four 0402 discrettes and over 70% vs four 0603 discrete capacitors.

#### W3A (0612) Capacitor Arrays

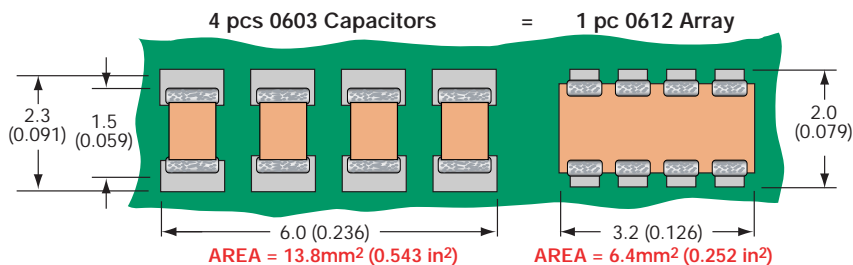

The 0612 4-element capacitor array gives a PCB space saving of over 50% vs four 0603 discrettes and over 70% vs four 0805 discrete capacitors.



# Capacitor Array

## Multi-Value Capacitor Array (IPC)

### GENERAL DESCRIPTION

A recent addition to the array product range is the Multi-Value Capacitor Array. These devices combine two different capacitance values in standard 'Cap Array' packages and are available with a maximum ratio between the two capacitance values of 100:1. The multi-value array is currently available in the 0405 and 0508 2-element styles and also in the 0612 4-element style.

Whereas to date AVX capacitor arrays have been suited to applications where multiple capacitors of the same value are used, the multi-value array introduces a new flexibility to the range. The multi-value array can replace discrete capacitors of different values and can be used for broadband decoupling applications. The 0508 x 2 element multi-value array would be particularly recommended in this application. Another application is filtering the 900/1800 or 1900MHz noise in mobile phones. The 0405 2-element, low capacitance value NPO, (COG) device would be suited to this application, in view of the space saving requirements of mobile phone manufacturers.

### ADVANTAGES OF THE MULTI-VALUE CAPACITOR ARRAYS

#### Enhanced Performance Due to Reduced Parasitic Inductance

When connected in parallel, not only do discrete capacitors of different values give the desired self-resonance, but an additional unwanted parallel resonance also results. This parallel resonance is induced between each capacitor's self-resonant frequencies and produces a peak in impedance response. For decoupling and bypassing applications this peak will result in a frequency band of reduced decoupling and in filtering applications reduced attenuation.

The multi-value capacitor array, combining capacitors in one unit, virtually eliminates the problematic parallel resonance, by minimizing parasitic inductance between the capacitors, thus enhancing the broadband decoupling/filtering performance of the part.

#### Reduced ESR

An advantage of connecting two capacitors in parallel is a significant reduction in ESR. However, as stated above, using discrete components brings with it the unwanted side effect of parallel resonance. The multi-value cap array is an excellent alternative as not only does it perform the same function as parallel capacitors but also it reduces the uncertainty of the frequency response.

### HOW TO ORDER

<b>W</b>   Style	<b>2</b>   Case Size	<b>A</b>   Array	<b>2</b>   Number of Caps	<b>Y</b>   Voltage	<b>C</b>   Dielectric	<b>102M</b> 1st Value	<b>104M</b> 2nd Value	<b>A</b>   Failure Rate	<b>T</b>   Termination Code	<b>2A</b>   Packaging & Quantity Code
	1 = 0405 2 = 0508 3 = 0612			6 = 6.3V Z = 10V Y = 16V 3 = 25V 5 = 50V 1 = 100V	A = NPO C = X7R D = X5R	Capacitance Code (In pF) 2 Sig. Digits + Number of Zeros	Capacitance Tolerance K = ±10% M = ±20%		T = Plated Ni and Sn	2A = 7" Reel (4000) 4A = 13" Reel (10000) 2F = 7" Reel (1000)

	Cap (Min/Max)	
	NPO	X5R/X7R
<b>0612 4-element</b>	100/471	221/104
<b>0508 2-element</b>	100/471	221/104
<b>0405 2-element</b>	100/101	101/103

- Max. ratio between the two cap values is 1:100.
- The voltage of the higher capacitance value dictates the voltage of the multi-value part.
- Only combinations of values within a specific dielectric range are possible.

### IMPEDANCE VS FREQUENCY

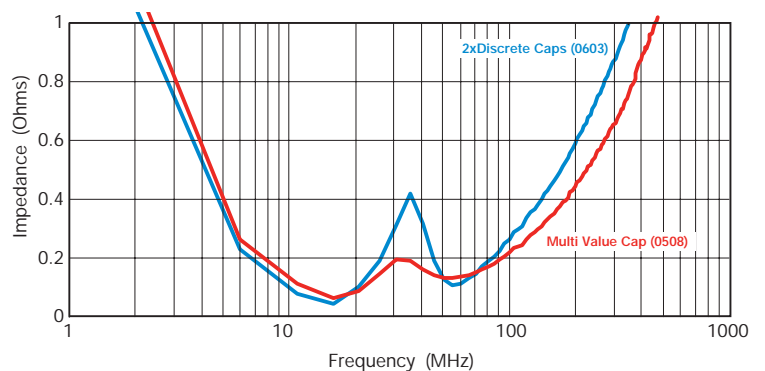

## PART & PAD LAYOUT DIMENSIONS

millimeters (inches)

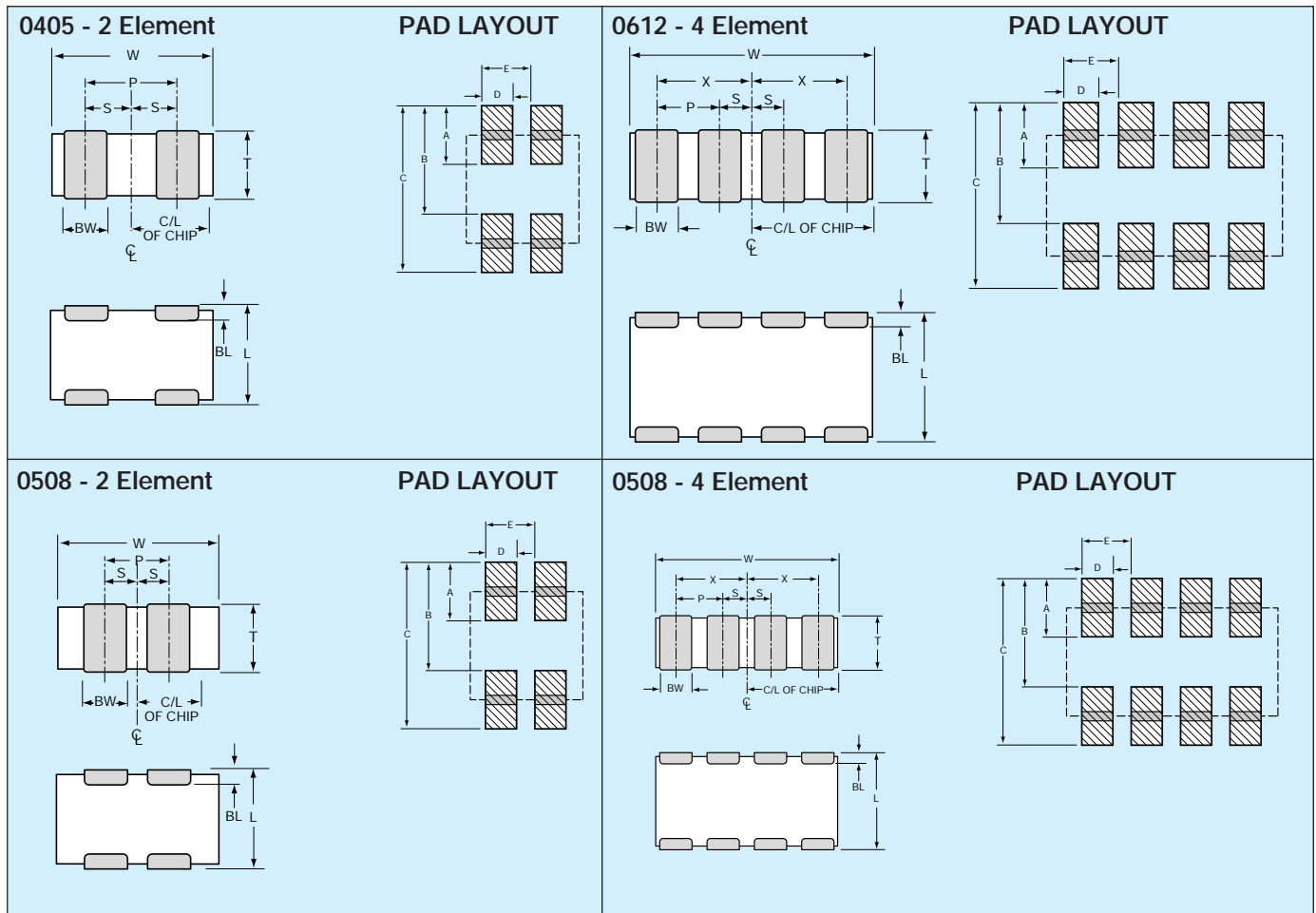

## PART DIMENSIONS

### 0405 - 2 Element

L	W	T	BW	BL	P	S
1.00 ± 0.15 (0.039 ± 0.006)	1.37 ± 0.15 (0.054 ± 0.006)	0.66 MAX (0.026 MAX)	0.36 ± 0.10 (0.014 ± 0.004)	0.20 ± 0.10 (0.008 ± 0.004)	0.64 REF (0.025 REF)	0.32 ± 0.10 (0.013 ± 0.004)

### 0508 - 2 Element

L	W	T	BW	BL	P	S
1.30 ± 0.15 (0.051 ± 0.006)	2.10 ± 0.15 (0.083 ± 0.006)	0.94 MAX (0.037 MAX)	0.43 ± 0.10 (0.017 ± 0.004)	0.33 ± 0.08 (0.013 ± 0.003)	1.00 REF (0.039 REF)	0.50 ± 0.10 (0.020 ± 0.004)

### 0508 - 4 Element

L	W	T	BW	BL	P	X	S
1.30 ± 0.15 (0.051 ± 0.006)	2.10 ± 0.15 (0.083 ± 0.006)	0.94 MAX (0.037 MAX)	0.25 ± 0.06 (0.010 ± 0.003)	0.20 ± 0.08 (0.008 ± 0.003)	0.50 REF (0.020 REF)	0.75 ± 0.10 (0.030 ± 0.004)	0.25 ± 0.10 (0.010 ± 0.004)

### 0612 - 4 Element

L	W	T	BW	BL	P	X	S
1.60 ± 0.20 (0.063 ± 0.008)	3.20 ± 0.20 (0.126 ± 0.008)	1.35 MAX (0.053 MAX)	0.41 ± 0.10 (0.016 ± 0.004)	0.18 ± 0.08 (0.007 ± 0.003)	0.76 REF (0.030 REF)	1.14 ± 0.10 (0.045 ± 0.004)	0.38 ± 0.10 (0.015 ± 0.004)

## PAD LAYOUT DIMENSIONS

### 0405 - 2 Element

A	B	C	D	E
0.46 (0.018)	0.74 (0.029)	1.20 (0.047)	0.30 (0.012)	0.64 (0.025)

### 0508 - 2 Element

A	B	C	D	E
0.68 (0.027)	1.32 (0.052)	2.00 (0.079)	0.46 (0.018)	1.00 (0.039)

### 0508 - 4 Element

A	B	C	D	E
0.56 (0.022)	1.32 (0.052)	1.88 (0.074)	0.30 (0.012)	0.50 (0.020)

### 0612 - 4 Element

A	B	C	D	E
0.89 (0.035)	1.65 (0.065)	2.54 (0.100)	0.46 (0.018)	0.79 (0.031)

# Low Inductance Capacitors



## Introduction

As switching speeds increase and pulse rise times decrease the need to reduce inductance becomes a serious limitation for improved system performance. Even the decoupling capacitors, that act as a local energy source, can generate unacceptable voltage spikes:  $V = L (di/dt)$ . Thus, in high speed circuits, where  $di/dt$  can be quite large, the size of the voltage spike can only be reduced by reducing L.

Figure 1 displays the evolution of ceramic capacitor toward lower inductance designs over the last few years. AVX has been at the forefront in the design and manufacture of these newer more effective capacitors.

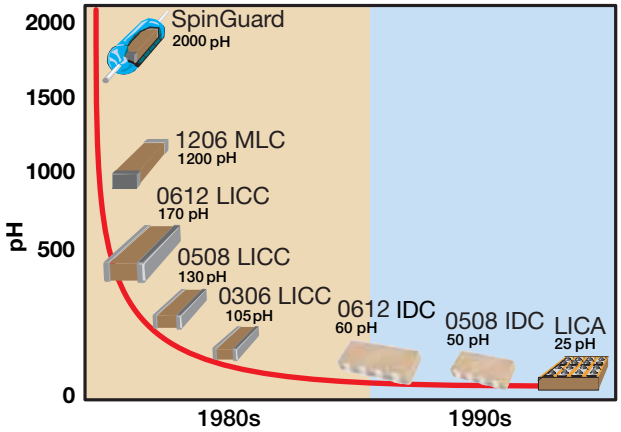

Figure 1. The evolution of Low Inductance Capacitors at AVX (values given for a 100 nF capacitor of each style)

## LOW INDUCTANCE CHIP CAPACITORS

The total inductance of a chip capacitor is determined both by its length to width ratio and by the mutual inductance coupling between its electrodes. Thus a 1210 chip size has lower inductance than a 1206 chip. This design improvement is the basis of AVX's low inductance chip capacitors, LI Caps, where the electrodes are terminated on the long side of the chip instead of the short side. The 1206 becomes an 0612 as demonstrated in Figure 2. In the same manner, an 0805 becomes an 0508 and 0603 becomes an 0306. This results in a reduction in inductance from around 1200 pF for conventional MLC chips to below 200 pF for Low Inductance Chip Capacitors. Standard designs and performance of these LI Caps are given on pages 46 and 47.

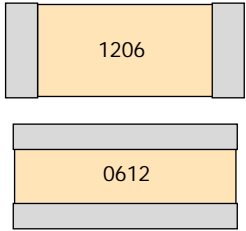
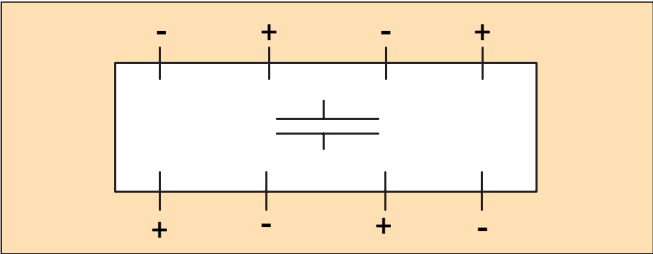

Figure 2. Change in aspect ratio: 1206 vs. 0612

## INTERDIGITATED CAPACITORS

Multiple terminations of a capacitor will also help in reducing the parasitic inductance of the device. The IDC is such a device. By terminating one capacitor with 8 connections the ESL can be reduced even further. The measured inductance of the 0612 IDC is 60 pF, while the 0508 comes in around 50 pF. These FR4 mountable devices allow for even higher clock speeds in a digital decoupling scheme. Design and product offerings are shown on pages 48 and 49.



## LOW INDUCTANCE CHIP ARRAYS (LICA®)

Further reduction in inductance can be achieved by designing alternative current paths to minimize the mutual inductance factor of the electrodes (Figure 3). This is achieved by AVX's LICA® product which was the result of a joint development between AVX and IBM. As shown in Figure 4, the charging current flowing out of the positive plate returns in the opposite direction along adjacent negative plates. This minimizes the mutual inductance.

The very low inductance of the LICA capacitor stems from the short aspect ratio of the electrodes, the arrangement of the tabs so as to cancel inductance, and the vertical aspect of the electrodes to the mounting surface.

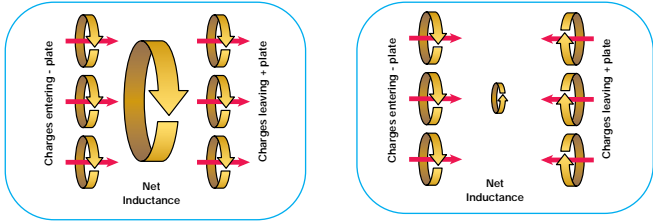

Figure 3. Net Inductance from design. In the standard Multilayer capacitor, the charge currents entering and leaving the capacitor create complementary flux fields, so the net inductance is greater. On the right, however, if the design permits the currents to be opposed, there is a net cancellation, and the inductance is much lower.



# Low Inductance Capacitors



## Introduction

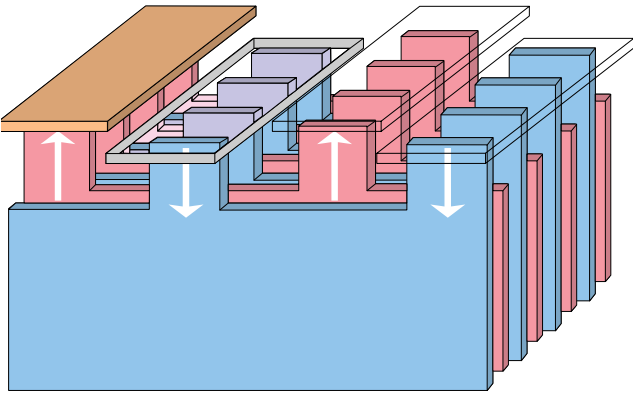

Figure 4. LICA's Electrode/Termination Construction. The current path is minimized – this reduces self-inductance. Current flowing out of the positive plate, returns in the opposite direction along the adjacent negative plate – this reduces the mutual inductance.

Also the effective current path length is minimized because the current does not have to travel the entire length of both electrodes to complete the circuit. This reduces the self inductance of the electrodes. The self inductance is also minimized by the fact that the charging current is supplied by both sets of terminals reducing the path length even further!

The inductance of this arrangement is less than 30 pH, causing the self-resonance to be above 100 MHz for the same popular 100 nF capacitance. Parts available in the LICA design are shown on pages 50 and 51.

Figure 5 compares the self resonant frequencies of various capacitor designs versus capacitance values. The approximate inductance of each style is also shown.

Active development continues on low inductance capacitors. C4 termination with low temperature solder is now available for plastic packages. Consult AVX for details.

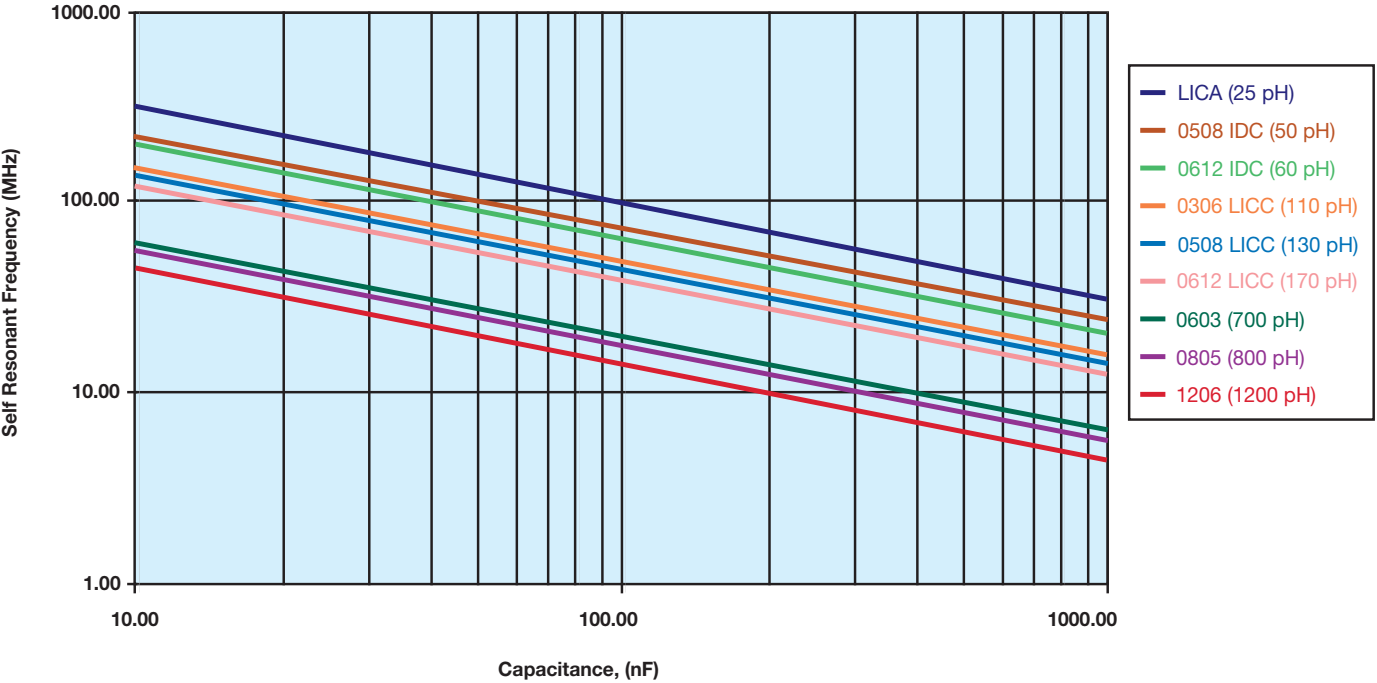

Figure 5. Self Resonant Frequency vs. Capacitance and Capacitor Design

# Low Inductance Capacitors



## 0612/0508/0306 LICC (Low Inductance Chip Capacitors)

### GENERAL DESCRIPTION

The total inductance of a chip capacitor is determined both by its length to width ratio and by the mutual inductance coupling between its electrodes.

Thus a 1210 chip size has a lower inductance than a 1206 chip. This design improvement is the basis of AVX's Low Inductance Chip Capacitors (LICC), where the electrodes are terminated on the long side of the chip instead of the short side. The 1206 becomes an 0612, in the same manner, an 0805 becomes an 0508, an 0603 becomes an 0306. This results in a reduction in inductance from the 1nH range found in normal chip capacitors to less than 0.2nH for LICCs. Their low profile is also ideal for surface mounting (both on the PCB and on IC package) or inside cavity mounting on the IC itself.

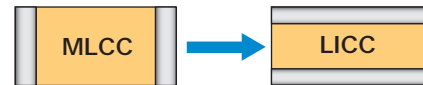
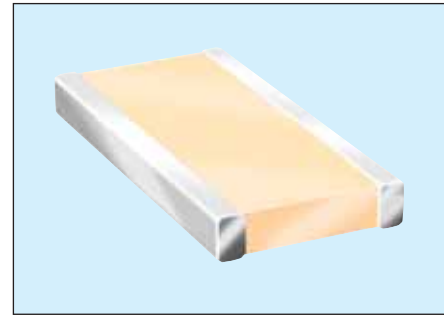

### HOW TO ORDER

#### 0612

**Size**  
0306  
0508  
0612

#### Z

**Voltage**  
6 = 6.3V  
Z = 10V  
Y = 16V  
3 = 25V  
5 = 50V

#### D

**Dielectric**  
C = X7R  
D = X5R

#### 105

**Capacitance Code (In pF)**  
2 Sig. Digits + Number of Zeros

#### M

**Capacitance Tolerance**  
K =  $\pm 10\%$   
M =  $\pm 20\%$

#### A

**Failure Rate**  
A = N/A

#### T

**Terminations**  
T = Plated Ni and Sn  
J = Tin/Lead

#### 2

**Packaging Available**  
2 = 7" Reel  
4 = 13" Reel

#### A\*

**Thickness**  
**Thickness**  
mm (in)  
0.56 (0.022)  
0.61 (0.024)  
0.76 (0.030)  
1.02 (0.040)  
1.27 (0.050)

### PERFORMANCE CHARACTERISTICS

Capacitance Tolerances	K = $\pm 10\%$ ; M = $\pm 20\%$
Operation Temperature Range	X7R = -55°C to +125°C; X5R = -55°C to +85°C
Temperature Coefficient	$\pm 15\%$ (0VDC)
Voltage Ratings	6.3, 10, 16, 25 VDC
Dissipation Factor	6.3V = 6.5% max; 10V = 5.0% max; 16V = 3.5% max; 25V = 3.0% max
Insulation Resistance (@+25°C, RVDC)	100,000M $\Omega$ min, or 1,000M $\Omega$ per $\mu$ F min., whichever is less

### TYPICAL INDUCTANCE

Package Style	Measured Inductance (pH)
1206 MLCC	1200
0612 LICC	170
0508 LICC	130
0306 LICC	105

\*Note: See Range Chart for Codes

### TYPICAL IMPEDANCE CHARACTERISTICS

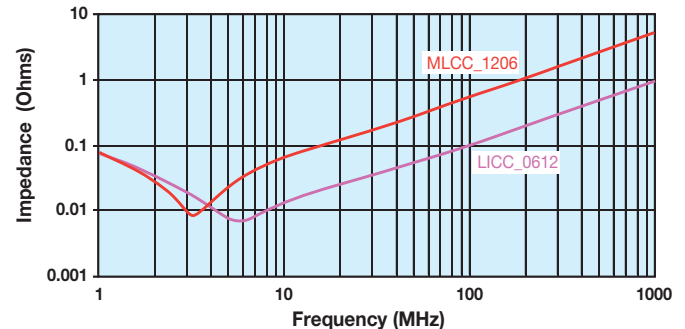
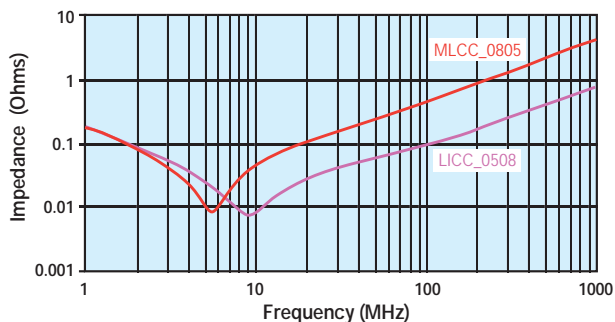

# Low Inductance Capacitors



## 0612/0508/0306 LICC (Low Inductance Chip Capacitors)

SIZE	0306					0508					0612				
Packaging	Embossed					Embossed					Embossed				
Length	0.81 ± 0.15 (0.032 ± 0.006)					1.27 ± 0.25 (0.050 ± 0.010)					1.60 ± 0.25 (0.063 ± 0.010)				
Width	1.60 ± 0.15 (0.063 ± 0.006)					2.00 ± 0.25 (0.080 ± 0.010)					3.20 ± 0.25 (0.126 ± 0.010)				
WVDC	6.3	10	16	25	50	6.3	10	16	25	50	6.3	10	16	25	50
CAP (uF)	0.001														
	0.0022														
	0.0047														
	0.010														
	0.015														
	0.022														
	0.047														
	0.068														
	0.10														
	0.15														
	0.22														
	0.47														
	0.68														
	1.0														
	1.5														
	2.2														
	3.3														
	4.7														
	10														

### PHYSICAL DIMENSIONS AND PAD LAYOUT

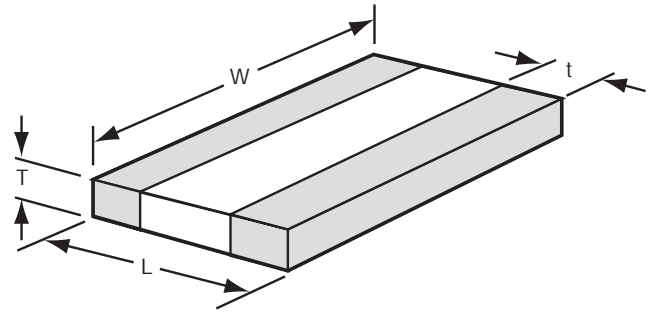

### PHYSICAL CHIP DIMENSIONS

mm (in)

	L	W	t
<b>0612</b>	1.60 ± 0.25 (0.063 ± 0.010)	3.20 ± 0.25 (0.126 ± 0.010)	0.13 min. (0.005 min.)
<b>0508</b>	1.27 ± 0.25 (0.050 ± 0.010)	2.00 ± 0.25 (0.080 ± 0.010)	0.13 min. (0.005 min.)
<b>0306</b>	0.81 ± 0.15 (0.032 ± 0.006)	1.60 ± 0.15 (0.063 ± 0.006)	0.13 min. (0.005 min.)

T - See Range Chart for Thickness and Codes

### PAD LAYOUT DIMENSIONS

mm (in)

	A	B	C
<b>0612</b>	0.76 (0.030)	3.05 (0.120)	.635 (0.025)
<b>0508</b>	0.51 (0.020)	2.03 (0.080)	0.51 (0.020)
<b>0306</b>	0.31 (0.012)	1.52 (0.060)	0.51 (0.020)

Solid = X7R

= X5R

mm (in.)	
0306	
Code	Thickness
A	0.61 (0.024)

mm (in.)	
0508	
Code	Thickness
S	0.56 (0.022)
V	0.76 (0.030)
A	1.02 (0.040)

mm (in.)	
0612	
Code	Thickness
S	0.56 (0.022)
V	0.76 (0.030)
W	1.02 (0.040)
A	1.27 (0.050)

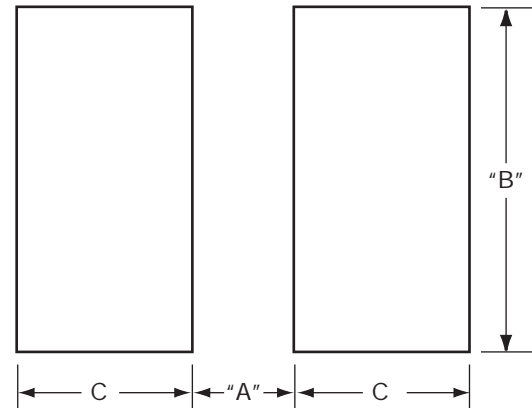



# Low Inductance Capacitors

## 0612/0508 IDC (InterDigitated Capacitors)



### GENERAL DESCRIPTION

- Very low equivalent series inductance (ESL), surface mountable, high speed decoupling capacitor in 0612 and 0508 case size.
- Measured inductances of 60 pH (for 0612) and 50 pH (for 0508) are the lowest in the FR4 mountable device family. Now use 10T devices with inductances of 45 pH (for 0612) and 35 pH (for 0508).
- Opposing current flow creates opposing magnetic fields. This causes the fields to cancel, effectively reducing the equivalent series inductance.
- Perfect solution for decoupling high speed microprocessors by allowing the engineers to lower the power delivery inductance of the entire system through the use of eight vias.
- Overall reduction in decoupling components due to very low series inductance and high capacitance.

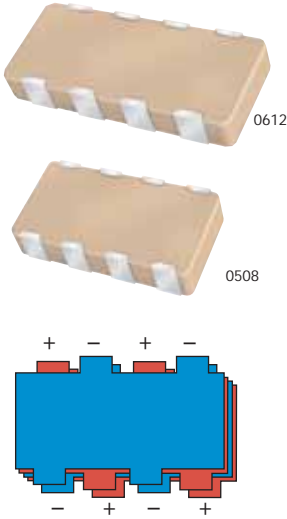

### HOW TO ORDER

<b>W</b>	<b>3</b>	<b>L</b>	<b>1</b>	<b>6</b>	<b>D</b>	<b>225</b>	<b>M</b>	<b>A</b>	<b>T</b>	<b>3</b>	<b>A</b>
<b>Style</b>	<b>Case Size</b>	<b>Low Inductance</b>	<b>Number of Terminals</b>	<b>Voltage</b>	<b>Dielectric</b>	<b>Capacitance Code (In pF)</b>	<b>Capacitance Tolerance</b>	<b>Failure Rate</b>	<b>Termination</b>	<b>Packaging</b>	<b>Thickness</b>
	2 = 0508 3 = 0612	ESL = 50pH ESL = 60pH	1 = 8 Terminals	4 = 4V 6 = 6.3V Z = 10V Y = 16V	C = X7R D = X5R	2 Sig. Digits + Number of Zeros	M = ±20%	A = N/A	T = Plated Ni and Sn	Available 1=7" Reel 3=13" Reel	Max. Thickness mm (in.) A=0.95 (0.037) S=0.55 (0.022)

### PERFORMANCE CHARACTERISTICS

<b>Capacitance Tolerance</b>	±20% Preferred
<b>Operation Temperature Range</b>	X7R = -55°C to +125°C; X5R = -55°C to +85°C
<b>Temperature Coefficient</b>	±15% (0VDC)
<b>Voltage Ratings</b>	4, 6.3, 10, 16 VDC
<b>Dissipation Factor</b>	4V, 6.3V = 6.5% max; 10V = 5.0% max; 16V = 3.5% max
<b>Insulation Resistance (@+25°C, RVDC)</b>	100,000MΩ min, or 1,000MΩ per μF min., whichever is less

<b>Dielectric Strength</b>	No problems observed after 2.5 x RVDC for 5 seconds at 50mA max current
<b>CTE (ppm/C)</b>	12.0
<b>Thermal Conductivity</b>	4-5W/M K
<b>Terminations Available</b>	Plated Nickel and Solder
<b>Max. Thickness</b>	0.037" (0.95mm)

### TYPICAL ESL AND IMPEDANCE

Package Style	Measured Inductance (pH)
1206 MLCC	1200
0612 LICC	170
0612 IDC	60
0508 IDC	50

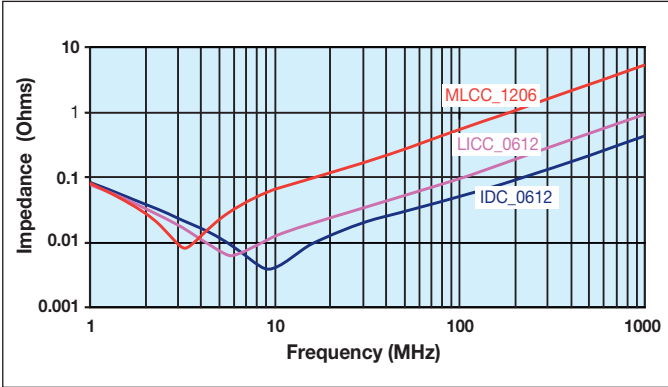

# Low Inductance Capacitors

## 0612/0508 IDC (InterDigitated Capacitors)

SIZE	Thin 0508				0508				Thin 0612				0612				
Length	MM (in.)	2.03 ± 0.20 (0.080 ± 0.008)				2.03 ± 0.20 (0.080 ± 0.008)				3.20 ± 0.20 (0.126 ± 0.008)				3.20 ± 0.20 (0.126 ± 0.008)			
Width	MM (in.)	1.27 ± 0.20 (0.050 ± 0.008)				1.27 ± 0.20 (0.050 ± 0.008)				1.60 ± 0.20 (0.063 ± 0.008)				1.60 ± 0.20 (0.063 ± 0.008)			
Terminal Pitch	MM (in.)	0.508 REF 0.020 REF				0.508 REF 0.020 REF				0.76 REF 0.030 REF				0.76 REF 0.030 REF			
Thickness	MM (in.)	0.55 MAX. (0.022) MAX.				0.95 MAX. (0.037) MAX.				0.55 MAX. (0.022) MAX.				0.95 MAX. (0.037) MAX.			
Inductance (pH)		95				95				120				120			
WVDC		4	6.3	10	16	4	6.3	10	16	4	6.3	10	16	4	6.3	10	16
CAP (uF) and Thickness																	
0.047																	
0.068																	
0.10																	
0.22																	
0.33																	
0.47																	
0.68																	
1.0																	
1.5																	
2.2																	
3.3																	

Consult factory for additional requirements

= X7R  
 = X5R

### PHYSICAL DIMENSIONS AND PAD LAYOUT

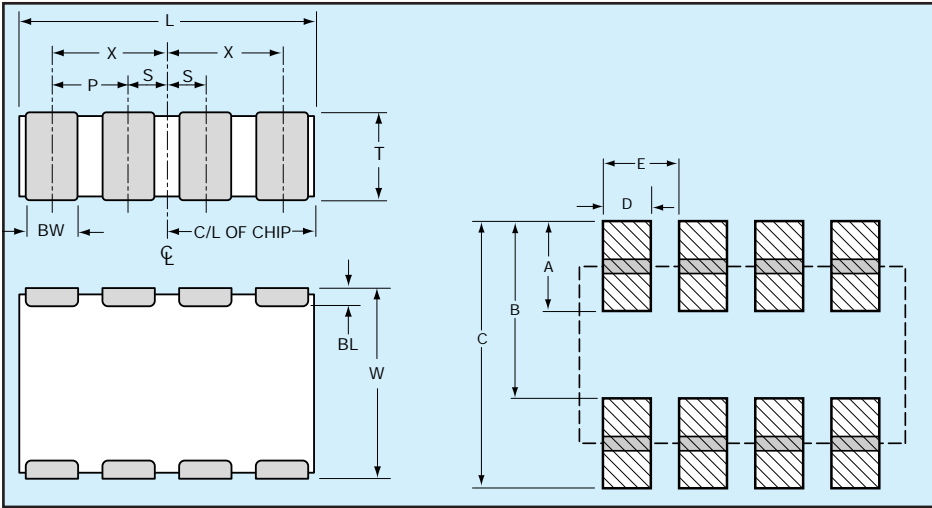

### PHYSICAL CHIP DIMENSIONS millimeters (inches)

#### 0612

L	W	BW	BL	P	X	S
3.20 ± 0.20 (0.126 ± 0.008)	1.60 ± 0.20 (0.063 ± 0.008)	0.41 ± 0.10 (0.016 ± 0.004)	0.18 <sup>+0.25</sup> <sub>-0.08</sub> (0.007 <sup>+0.010</sup> <sub>-0.003</sub> )	0.76 REF (0.030 REF)	1.14 ± 0.10 (0.045 ± 0.004)	0.38 ± 0.10 (0.015 ± 0.004)

#### 0508

L	W	BW	BL	P	X	S
2.03 ± 0.20 (0.080 ± 0.008)	1.27 ± 0.20 (0.050 ± 0.008)	0.254 ± 0.10 (0.010 ± 0.004)	0.18 <sup>+0.25</sup> <sub>-0.08</sub> (0.007 <sup>+0.010</sup> <sub>-0.003</sub> )	0.508 REF (0.020 REF)	0.76 ± 0.10 (0.030 ± 0.004)	0.254 ± 0.10 (0.010 ± 0.004)

### PAD LAYOUT DIMENSIONS

#### 0612

A	B	C	D	E
0.89 (0.035)	1.65 (0.065)	2.54 (0.100)	0.46 (0.018)	0.76 (0.030)

#### 0508

A	B	C	D	E
0.64 (0.025)	1.27 (0.050)	1.91 (0.075)	0.28 (0.011)	0.51 (0.020)

# Low Inductance Capacitors



## LICA® (Low Inductance Decoupling Capacitor Arrays)

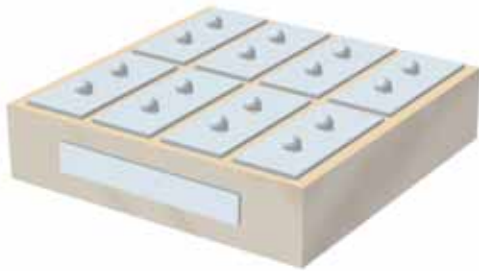

LICA® arrays utilize up to four separate capacitor sections in one ceramic body (see Configurations and Capacitance Options). These designs exhibit a number of technical advancements:

Low Inductance features–

- Low resistance platinum electrodes in a low aspect ratio pattern
- Double electrode pickup and perpendicular current paths
- C4 “flip-chip” technology for minimal interconnect inductance

### HOW TO ORDER

LICA	3	T	102	M	3	F	C	4	A	A
Style & Size	Voltage 5V = 9 10V = Z 25V = 3	Dielectric D = X5R T = T55T S = High K T55T	Cap/Section (EIA Code) 102 = 1000 pF 103 = 10 nF 104 = 100 nF	Capacitance Tolerance M = ±20% P = GMV	Height Code 6 = 0.500mm 3 = 0.650mm 1 = 0.875mm 5 = 1.100mm 7 = 1.600mm	Termination F = C4 Solder Balls- 97Pb/3Sn H = C4 Solder Balls Low ESR P = Cr-Cu-Au N = Cr-Ni-Au X = None	Reel Packaging M = 7" Reel R = 13" Reel 6 = 2"x2" Waffle Pack 8 = 2"x2" Black Waffle Pack 7 = 2"x2" Waffle Pack w/ termination facing up A = 2"x2" Black Waffle Pack w/ termination facing up C = 4"x4" Waffle Pack w/ clear lid	# of Caps/Part 1 = one 2 = two 4 = four	Inspection Code A = Standard B = Established Reliability Testing	Code Face A = Bar B = No Bar C = Dot, S55S Dielectrics

TABLE 1

Typical Parameters	T55T	Units
Capacitance, 25°C	Co	Nanofarads
Capacitance, 55°C	1.4 x Co	Nanofarads
Capacitance, 85°C	Co	Nanofarads
Dissipation Factor 25°	12	Percent
DC Resistance	0.2	Ohms
IR (Minimum @25°)	2.0	Megaohms
Dielectric Breakdown, Min	500	Volts
Thermal Coefficient of Expansion	8.5	ppm/°C 25-100°
Inductance: (Design Dependent)	15 to 120	Pico-Henries
Frequency of Operation	DC to 5 Gigahertz	
Ambient Temp Range	-55° to 125°C	

### C4 AND PAD DIMENSIONS

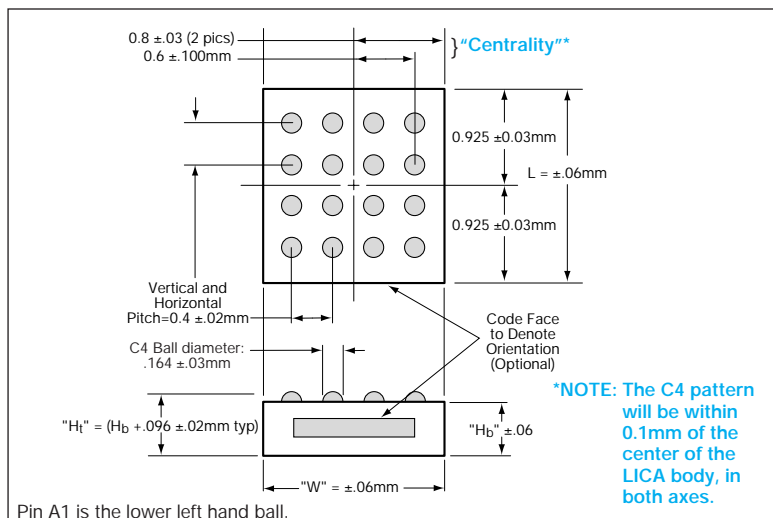

Pin A1 is the lower left hand ball.

Code (Body Height)	Width (W)	Length (L)	Height Body (H <sub>b</sub> )
1	1.600mm	1.850mm	0.875mm
3	1.600mm	1.850mm	0.650mm
5	1.600mm	1.850mm	1.100mm
6	1.600mm	1.850mm	0.500mm
7	1.600mm	1.850mm	1.600mm

### TERMINATION OPTIONS

#### C4 SOLDER (97% Pb/3% Sn) BALLS

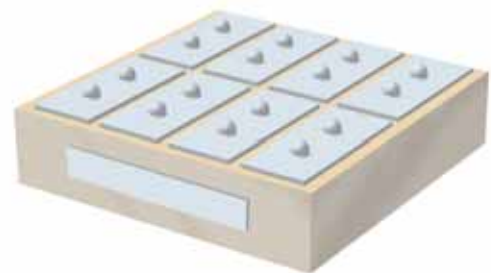

#### TERMINATION OPTION P OR N

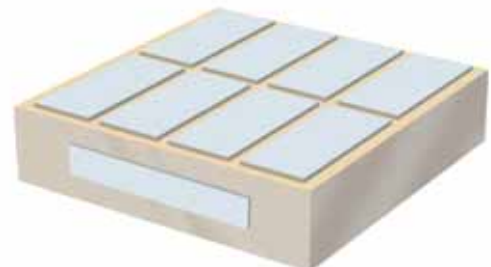

# Low Inductance Capacitors



## LICA® (Low Inductance Decoupling Capacitor Arrays)

### LICA® TYPICAL PERFORMANCE CURVES

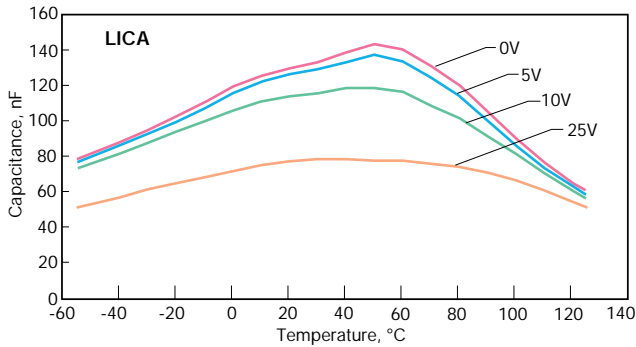

Effect of Bias Voltage and Temperature on a 130 nF LICA® (T55T)

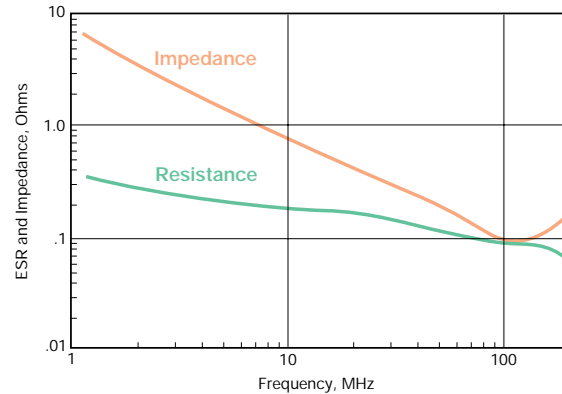

Impedance vs. Frequency

### LICA VALID PART NUMBER LIST

Part Number	Voltage	Thickness (mm)	Capacitors per Package
LICA3T193M3FC4AA	25	0.650	4
LICA3T153P3FC4AA	25	0.650	4
LICA3T134M1FC1AA	25	0.875	1
LICA3T104P1FC1AA	25	0.875	1
LICA3T333M1FC4AA	25	0.875	4
LICA3T263P3FC4AA	25	0.650	4
LICA3T244M5FC1AA	25	1.100	1
LICA3T194P5FC1AA	25	1.100	1
LICA3T394M7FC1AB	25	1.600	1
LICA3T314P7FC1AB	25	1.600	1
<b>Extended Range</b>			
LICAZT623M3FC4AB	10	0.650	4
LICA3T104M3FC1A	25	0.650	1
LICA3T803P3FC1A	25	0.650	1
LICA3T503M3FC2A	25	0.650	2
LICA3T403P3FC2A	25	0.650	2
LICA3S253M3FC4A	25	0.650	4

### CONFIGURATION

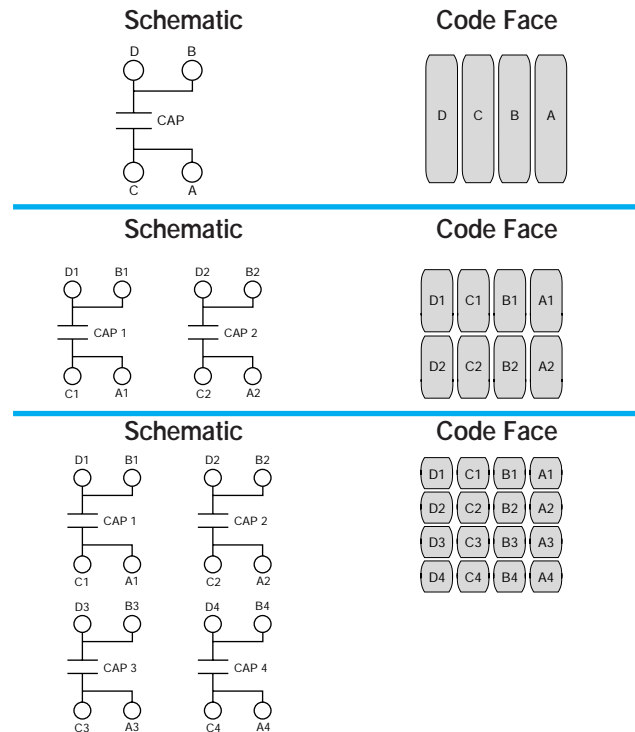

### WAFFLE PACK OPTIONS FOR LICA®

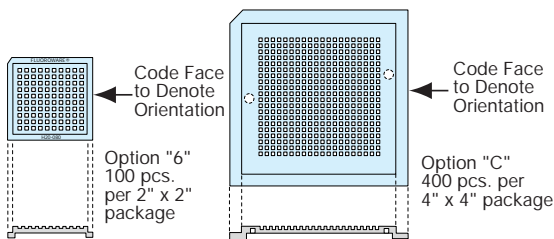

Note: Standard configuration is Termination side down

### LICA® PACKAGING SCHEME "M" AND "R"

8mm conductive plastic tape on reel:  
 "M"=7" reel max. qty. 3,000, "R"=13" reel max. qty. 8,000

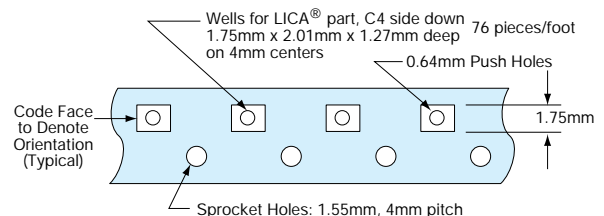

# High Voltage MLC Chips



For 600V to 5000V Application

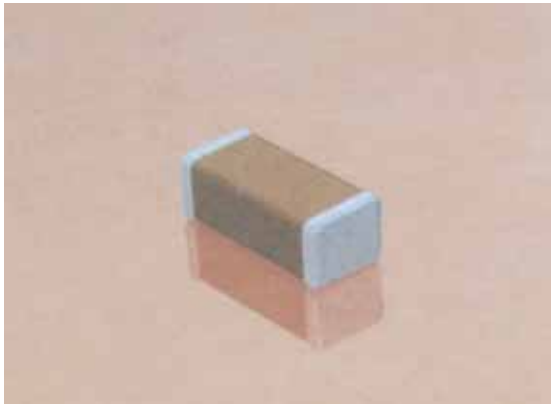

High value, low leakage and small size are difficult parameters to obtain in capacitors for high voltage systems. AVX special high voltage MLC chips capacitors meet these performance characteristics and are designed for applications such as snubbers in high frequency power converters, resonators in SMPS, and high voltage coupling/DC blocking. These high voltage chip designs exhibit low ESRs at high frequencies.

Larger physical sizes than normally encountered chips are used to make high voltage chips. These larger sizes require that special precautions be taken in applying these chips in surface mount assemblies. This is due to differences in the coefficient of thermal expansion (CTE) between the substrate materials and chip capacitors. Apply heat at less than 4°C per second during the preheat. The preheat temperature must be within 50°C of the peak temperature reached by the ceramic bodies through the soldering process. Chips 1808 and larger to use reflow soldering only.

Capacitors with X7R Dielectrics are not intended for AC line filtering applications. Contact plant for recommendations.

Capacitors may require protective surface coating to prevent external arcing.

## HOW TO ORDER

1808	A	A	271	K	A	1	1	A
<b>AVX Style</b>	<b>Voltage</b>	<b>Temperature Coefficient</b>	<b>Capacitance Code</b> (2 significant digits + no. of zeros)	<b>Capacitance Tolerance</b>	<b>Test Level</b>	<b>Termination*</b>	<b>Packaging</b>	<b>Special Code</b>
1206 1210 1808 1812 1825 2220 2225 3640	600V = C 1000V = A 1500V = S 2000V = G 2500V = W 3000V = H 4000V = J 5000V = K	COG = A X7R = C	Examples: 10 pF = 100 100 pF = 101 1,000 pF = 102 22,000 pF = 223 220,000 pF = 224 1 μF = 105	COG: J = ±5% K = ±10% M = ±20% X7R: K = ±10% M = ±20% Z = +80%, -20%	A = Standard	1 = Pd/Ag T = NiGuard Nickel Barrier Solderable Plate	1 = 7" Reel 3 = 13" Reel 9 = Bulk	A = Standard

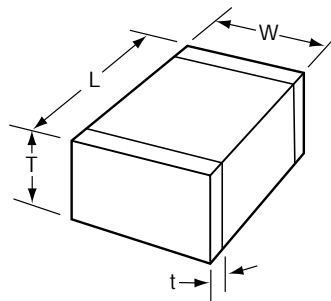

## DIMENSIONS

millimeters (inches)

SIZE	1206	1210	1808*	1812*	1825*	2220*	2225*	3640*
(L) Length	3.20 ± 0.2 (0.126 ± 0.008)	3.20 ± 0.2 (0.126 ± 0.008)	4.57 ± 0.25 (0.180 ± 0.010)	4.50 ± 0.3 (0.177 ± 0.012)	4.50 ± 0.3 (0.177 ± 0.012)	5.7 ± 0.4 (0.224 ± 0.016)	5.72 ± 0.25 (0.225 ± 0.010)	9.14 ± 0.25 (0.360 ± 0.010)
(W) Width	1.60 ± 0.2 (0.063 ± 0.008)	2.50 ± 0.2 (0.098 ± 0.008)	2.03 ± 0.25 (0.080 ± 0.010)	3.20 ± 0.2 (0.126 ± 0.008)	6.40 ± 0.3 (0.252 ± 0.012)	5.0 ± 0.4 (0.197 ± 0.016)	6.35 ± 0.25 (0.250 ± 0.010)	10.2 ± 0.25 (0.400 ± 0.010)
(T) Thickness Max.	1.52 (0.060)	1.70 (0.067)	2.03 (0.080)	2.54 (0.100)	2.54 (0.100)	3.3 (0.130)	2.54 (0.100)	2.54 (0.100)
(t) terminal min. max.	0.25 (0.010) 0.75 (0.030)	0.25 (0.010) 0.75 (0.030)	0.25 (0.010) 1.02 (0.040)	0.25 (0.010) 1.02 (0.040)	0.25 (0.010) 1.02 (0.040)	0.25 (0.010) 1.02 (0.040)	0.25 (0.010) 1.02 (0.040)	0.76 (0.030) 1.52 (0.060)

\*Reflow Soldering Only



# High Voltage MLC Chips



For 600V to 5000V Applications

## C0G Dielectric

### Performance Characteristics

Capacitance Range	10 pF to 0.047 $\mu$ F (25°C, 1.0 $\pm$ 0.2 Vrms at 1kHz, for $\leq$ 1000 pF use 1 MHz)
Capacitance Tolerances	$\pm$ 5%, $\pm$ 10%, $\pm$ 20%
Dissipation Factor	0.1% max. (+25°C, 1.0 $\pm$ 0.2 Vrms, 1kHz, for $\leq$ 1000 pF use 1 MHz)
Operating Temperature Range	-55°C to +125°C
Temperature Characteristic	0 $\pm$ 30 ppm/°C (0 VDC)
Voltage Ratings	600, 1000, 1500, 2000, 2500, 3000, 4000 & 5000 VDC (+125°C)
Insulation Resistance (+25°C, at 500 VDC)	100K M $\Omega$ min. or 1000 M $\Omega$ - $\mu$ F min., whichever is less
Insulation Resistance (+125°C, at 500 VDC)	10K M $\Omega$ min. or 100 M $\Omega$ - $\mu$ F min., whichever is less
Dielectric Strength	120% rated voltage for 5 seconds at 50 mA max. current

## HIGH VOLTAGE C0G CAPACITANCE VALUES

VOLTAGE	1206	1210	1808	1812	1825	2220	2225	3640
600 min.	10 pF	100 pF	100 pF	100 pF	1000 pF	1000 pF	1000 pF	1000 pF
600 max.	680 pF	1500 pF	2700 pF	5600 pF	0.012 $\mu$ F	0.012 $\mu$ F	0.015 $\mu$ F	0.047 $\mu$ F
1000 min.	10 pF	10 pF	100 pF	100 pF	100 pF	1000 pF	1000 pF	1000 pF
1000 max.	470 pF	820 pF	1500 pF	2700 pF	6800 pF	0.010 $\mu$ F	0.010 $\mu$ F	0.018 $\mu$ F
1500 min.	10 pF	10 pF	10 pF	10 pF	100 pF	100 pF	100 pF	100 pF
1500 max.	150 pF	330 pF	470 pF	1000 pF	2700 pF	2700 pF	3300 pF	8200 pF
2000 min.	10 pF	10 pF	10 pF	10 pF	100 pF	100 pF	100 pF	100 pF
2000 max.	68 pF	150 pF	270 pF	680 pF	1800 pF	2200 pF	2200 pF	5600 pF
2500 min.	—	—	10 pF	10 pF	10 pF	100 pF	100 pF	100 pF
2500 max.	—	—	150 pF	390 pF	1000 pF	1000 pF	1200 pF	3900 pF
3000 min.	—	—	10 pF	10 pF	10 pF	10 pF	10 pF	100 pF
3000 max.	—	—	100 pF	330 pF	680 pF	680 pF	820 pF	2200 pF
4000 min.	—	—	10 pF	10 pF	10 pF	10 pF	10 pF	100 pF
4000 max.	—	—	39 pF	100 pF	220 pF	220 pF	330 pF	1000 pF
5000 min.	—	—	—	—	—	—	—	10 pF
5000 max.	—	—	—	—	—	—	—	680 pF

## X7R Dielectric

### Performance Characteristics

Capacitance Range	10 pF to 0.56 $\mu$ F (25°C, 1.0 $\pm$ 0.2 Vrms at 1kHz)
Capacitance Tolerances	$\pm$ 10%; $\pm$ 20%; +80%, -20%
Dissipation Factor	2.5% max. (+25°C, 1.0 $\pm$ 0.2 Vrms, 1kHz)
Operating Temperature Range	-55°C to +125°C
Temperature Characteristic	$\pm$ 15% (0 VDC)
Voltage Ratings	600, 1000, 1500, 2000, 2500, 3000, 4000 & 5000 VDC (+125°C)
Insulation Resistance (+25°C, at 500 VDC)	100K M $\Omega$ min. or 1000 M $\Omega$ - $\mu$ F min., whichever is less
Insulation Resistance (+125°C, at 500 VDC)	10K M $\Omega$ min. or 100 M $\Omega$ - $\mu$ F min., whichever is less
Dielectric Strength	120% rated voltage for 5 seconds at 50 mA max. current

## HIGH VOLTAGE X7R MAXIMUM CAPACITANCE VALUES

VOLTAGE	1206	1210	1808	1812	1825	2220	2225	3640
600 min.	1000 pF	1000 pF	1000 pF	1000 pF	0.01 $\mu$ F	0.01 $\mu$ F	0.01 $\mu$ F	0.01 $\mu$ F
600 max.	0.015 $\mu$ F	0.033 $\mu$ F	0.056 $\mu$ F	0.10 $\mu$ F	0.18 $\mu$ F	0.22 $\mu$ F	0.22 $\mu$ F	0.56 $\mu$ F
1000 min.	100 pF	1000 pF	1000 pF	1000 pF	1000 pF	1000 pF	1000 pF	0.01 $\mu$ F
1000 max.	5600 pF	0.015 $\mu$ F	0.018 $\mu$ F	0.027 $\mu$ F	0.10 $\mu$ F	0.10 $\mu$ F	0.10 $\mu$ F	0.22 $\mu$ F
1500 min.	100 pF	100 pF	100 pF	100 pF	1000 pF	1000 pF	1000 pF	1000 pF
1500 max.	1800 pF	3900 pF	6800 pF	0.012 $\mu$ F	0.033 $\mu$ F	0.039 $\mu$ F	0.047 $\mu$ F	0.068 $\mu$ F
2000 min.	10 pF	100 pF	100 pF	100 pF	100 pF	1000 pF	1000 pF	1000 pF
2000 max.	1000 pF	2200 pF	2700 pF	4700 pF	0.01 $\mu$ F	0.01 $\mu$ F	0.015 $\mu$ F	0.027 $\mu$ F
2500 min.	—	—	10 pF	10 pF	100 pF	100 pF	100 pF	1000 pF
2500 max.	—	—	1800 pF	3300 pF	6800 pF	8200 pF	0.01 $\mu$ F	0.022 $\mu$ F
3000 min.	—	—	10 pF	10 pF	100 pF	100 pF	100 pF	1000 pF
3000 max.	—	—	1500 pF	2200 pF	4700 pF	4700 pF	6800 pF	0.018 $\mu$ F
4000 min.	—	—	—	—	—	—	—	100 pF
4000 max.	—	—	—	—	—	—	—	6800 pF
5000 min.	—	—	—	—	—	—	—	100 pF
5000 max.	—	—	—	—	—	—	—	3300 pF

# MIL-PRF-55681/Chips

Part Number Example  
CDR01 thru CDR06

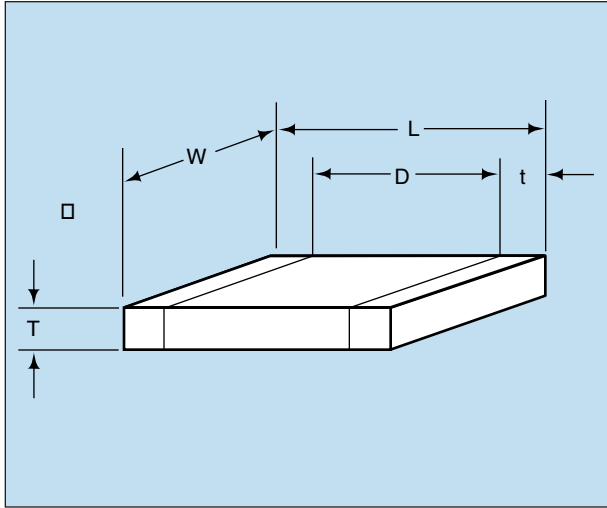

## MILITARY DESIGNATION PER MIL-PRF-55681

Part Number Example

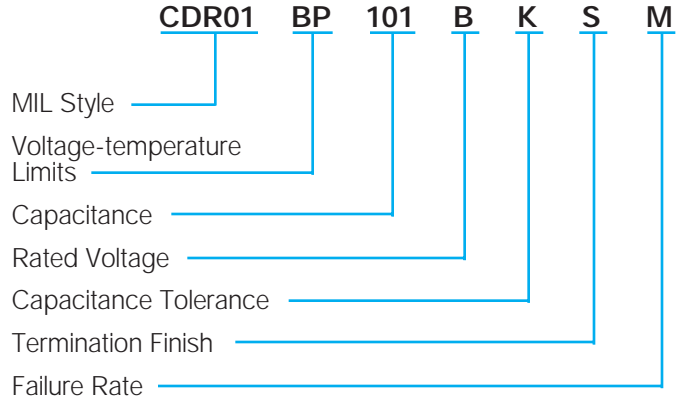

**MIL Style:** CDR01, CDR02, CDR03, CDR04, CDR05, CDR06

**Voltage Temperature Limits:**

BP =  $0 \pm 30$  ppm/°C without voltage;  $0 \pm 30$  ppm/°C with rated voltage from -55°C to +125°C

BX =  $\pm 15\%$  without voltage; +15 -25% with rated voltage from -55°C to +125°C

**Capacitance:** Two digit figures followed by multiplier (number of zeros to be added) e.g., 101 = 100 pF

**Rated Voltage:** A = 50V, B = 100V

**Capacitance Tolerance:** J  $\pm 5\%$ , K  $\pm 10\%$ , M  $\pm 20\%$

**Termination Finish:**

M = Palladium Silver  
N = Silver Nickel Gold  
S = Solder-coated

U = Base Metallization/Barrier Metal/Solder Coated\*  
W = Base Metallization/Barrier Metal/Tinned (Tin or Tin/Lead Alloy)

\*Solder shall have a melting point of 200°C or less.

**Failure Rate Level:** M = 1.0%, P = .1%, R = .01%, S = .001%

**Packaging:** Bulk is standard packaging. Tape and reel per RS481 is available upon request.

## CROSS REFERENCE: AVX/MIL-PRF-55681/CDR01 THRU CDR06\*

Per MIL-PRF-55681	AVX Style	Length (L)	Width (W)	Thickness (T)		D		Termination Band (t)	
				Max.	Min.	Max.	Min.	Max.	Min.
CDR01	0805	.080 $\pm$ .015	.050 $\pm$ .015	.055	.020	—	.030	—	.010
CDR02	1805	.180 $\pm$ .015	.050 $\pm$ .015	.055	.020	—	—	.030	.010
CDR03	1808	.180 $\pm$ .015	.080 $\pm$ .018	.080	.020	—	—	.030	.010
CDR04	1812	.180 $\pm$ .015	.125 $\pm$ .015	.080	.020	—	—	.030	.010
CDR05	1825	.180 $^{+.020}_{-.015}$	.250 $^{+.020}_{-.015}$	.080	.020	—	—	.030	.010
CDR06	2225	.225 $\pm$ .020	.250 $\pm$ .020	.080	.020	—	—	.030	.010

\*For CDR11, 12, 13, and 14 see AVX Microwave Chip Capacitor Catalog



# MIL-PRF-55681/Chips

## Military Part Number Identification

### CDR01 thru CDR06



#### CDR01 thru CDR06 to MIL-PRF-55681

Military Type Designation	Capacitance in pF	Capacitance tolerance	Rated temperature and voltage-temperature limits	WVDC
<b>AVX Style 0805/CDR01</b>				
CDR01BP100B---	10	J,K	BP	100
CDR01BP120B---	12	J	BP	100
CDR01BP150B---	15	J,K	BP	100
CDR01BP180B---	18	J	BP	100
CDR01BP220B---	22	J,K	BP	100
CDR01BP270B---	27	J	BP	100
CDR01BP330B---	33	J,K	BP	100
CDR01BP390B---	39	J	BP	100
CDR01BP470B---	47	J,K	BP	100
CDR01BP560B---	56	J	BP	100
CDR01BP680B---	68	J,K	BP	100
CDR01BP820B---	82	J	BP	100
CDR01BP101B---	100	J,K	BP	100
CDR01B--121B---	120	J,K	BP,BX	100
CDR01B--151B---	150	J,K	BP,BX	100
CDR01B--181B---	180	J,K	BP,BX	100
CDR01BX221B---	220	K,M	BX	100
CDR01BX271B---	270	K	BX	100
CDR01BX331B---	330	K,M	BX	100
CDR01BX391B---	390	K	BX	100
CDR01BX471B---	470	K,M	BX	100
CDR01BX561B---	560	K	BX	100
CDR01BX681B---	680	K,M	BX	100
CDR01BX821B---	820	K	BX	100
CDR01BX102B---	1000	K,M	BX	100
CDR01BX122B---	1200	K	BX	100
CDR01BX152B---	1500	K,M	BX	100
CDR01BX182B---	1800	K	BX	100
CDR01BX222B---	2200	K,M	BX	100
CDR01BX272B---	2700	K	BX	100
CDR01BX332B---	3300	K,M	BX	100
CDR01BX392A---	3900	K	BX	50
CDR01BX472A---	4700	K,M	BX	50
<b>AVX Style 1805/CDR02</b>				
CDR02BP221B---	220	J,K	BP	100
CDR02BP271B---	270	J	BP	100
CDR02BX392B---	3900	K	BX	100
CDR02BX472B---	4700	K,M	BX	100
CDR02BX562B---	5600	K	BX	100
CDR02BX682B---	6800	K,M	BX	100
CDR02BX822B---	8200	K	BX	100
CDR02BX103B---	10,000	K,M	BX	100
CDR02BX123A---	12,000	K	BX	50
CDR02BX153A---	15,000	K,M	BX	50
CDR02BX183A---	18,000	K	BX	50
CDR02BX223A---	22,000	K,M	BX	50

- Add appropriate failure rate
- Add appropriate termination finish
- Capacitance Tolerance

Military Type Designation	Capacitance in pF	Capacitance tolerance	Rated temperature and voltage-temperature limits	WVDC
<b>AVX Style 1808/CDR03</b>				
CDR03BP331B---	330	J,K	BP	100
CDR03BP391B---	390	J	BP	100
CDR03BP471B---	470	J,K	BP	100
CDR03BP561B---	560	J	BP	100
CDR03BP681B---	680	J,K	BP	100
CDR03BP821B---	820	J	BP	100
CDR03BP102B---	1000	J,K	BP	100
CDR03BX123B---	12,000	K	BX	100
CDR03BX153B---	15,000	K,M	BX	100
CDR03BX183B---	18,000	K	BX	100
CDR03BX223B---	22,000	K,M	BX	100
CDR03BX273B---	27,000	K	BX	100
CDR03BX333B---	33,000	K,M	BX	100
CDR03BX393A---	39,000	K	BX	50
CDR03BX473A---	47,000	K,M	BX	50
CDR03BX563A---	56,000	K	BX	50
CDR03BX683A---	68,000	K,M	BX	50
<b>AVX Style 1812/CDR04</b>				
CDR04BP122B---	1200	J	BP	100
CDR04BP152B---	1500	J,K	BP	100
CDR04BP182B---	1800	J	BP	100
CDR04BP222B---	2200	J,K	BP	100
CDR04BP272B---	2700	J	BP	100
CDR04BP332B---	3300	J,K	BP	100
CDR04BX393B---	39,000	K	BX	100
CDR04BX473B---	47,000	K,M	BX	100
CDR04BX563B---	56,000	K	BX	100
CDR04BX823A---	82,000	K	BX	50
CDR04BX104A---	100,000	K,M	BX	50
CDR04BX124A---	120,000	K	BX	50
CDR04BX154A---	150,000	K,M	BX	50
CDR04BX184A---	180,000	K	BX	50
<b>AVX Style 1825/CDR05</b>				
CDR05BP392B---	3900	J,K	BP	100
CDR05BP472B---	4700	J,K	BP	100
CDR05BP562B---	5600	J,K	BP	100
CDR05BX683B---	68,000	K,M	BX	100
CDR05BX823B---	82,000	K	BX	100
CDR05BX104B---	100,000	K,M	BX	100
CDR05BX124B---	120,000	K	BX	100
CDR05BX154B---	150,000	K,M	BX	100
CDR05BX224A---	220,000	K,M	BX	50
CDR05BX274A---	270,000	K	BX	50
CDR05BX334A---	330,000	K,M	BX	50
<b>AVX Style 2225/CDR06</b>				
CDR06BP682B---	6800	J,K	BP	100
CDR06BP822B---	8200	J,K	BP	100
CDR06BP103B---	10,000	J,K	BP	100
CDR06BX394A---	390,000	K	BX	50
CDR06BX474A---	470,000	K,M	BX	50

- Add appropriate failure rate
- Add appropriate termination finish
- Capacitance Tolerance



# MIL-PRF-55681/Chips

## Part Number Example CDR31 thru CDR35

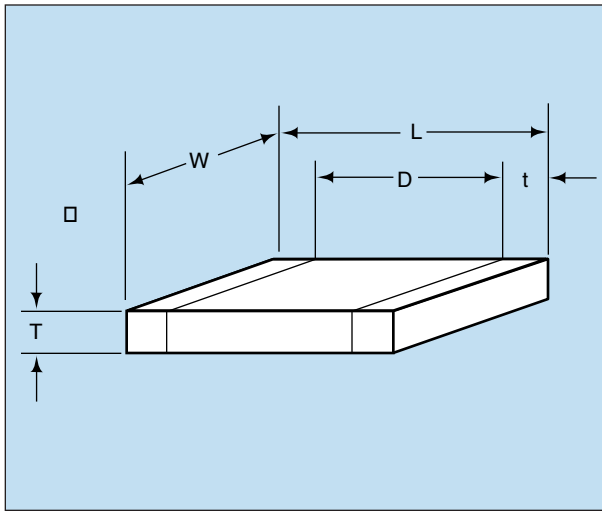

### MILITARY DESIGNATION PER MIL-PRF-55681

#### Part Number Example

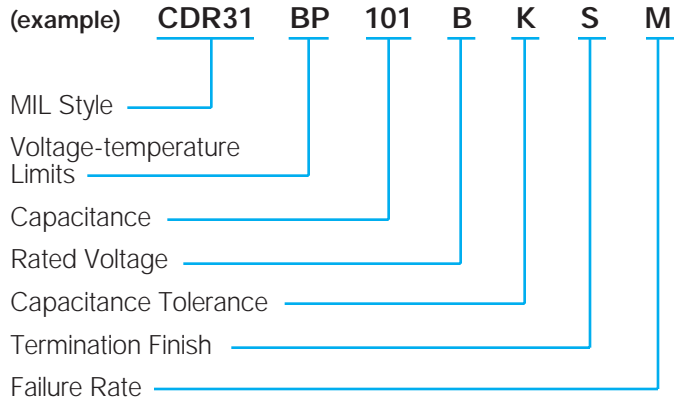

**MIL Style:** CDR31, CDR32, CDR33, CDR34, CDR35

#### Voltage Temperature Limits:

BP =  $0 \pm 30$  ppm/ $^{\circ}\text{C}$  without voltage;  $0 \pm 30$  ppm/ $^{\circ}\text{C}$  with rated voltage from  $-55^{\circ}\text{C}$  to  $+125^{\circ}\text{C}$

BX =  $\pm 15\%$  without voltage;  $+15 -25\%$  with rated voltage from  $-55^{\circ}\text{C}$  to  $+125^{\circ}\text{C}$

**Capacitance:** Two digit figures followed by multiplier (number of zeros to be added) e.g., 101 = 100 pF

**Rated Voltage:** A = 50V, B = 100V

**Capacitance Tolerance:** C  $\pm .25$  pF, D  $\pm .5$  pF, F  $\pm 1\%$   
J  $\pm 5\%$ , K  $\pm 10\%$ , M  $\pm 20\%$

#### Termination Finish:

M = Palladium Silver  
N = Silver Nickel Gold  
S = Solder-coated

U = Base Metallization/Barrier Metal/Solder Coated\*  
W = Base Metallization/Barrier Metal/Tinned (Tin or Tin/Lead Alloy)

\*Solder shall have a melting point of  $200^{\circ}\text{C}$  or less.

**Failure Rate Level:** M = 1.0%, P = .1%, R = .01%,  
S = .001%

**Packaging:** Bulk is standard packaging. Tape and reel per RS481 is available upon request.

### CROSS REFERENCE: AVX/MIL-PRF-55681/CDR31 THRU CDR35

Per MIL-PRF-55681 (Metric Sizes)	AVX Style	Length (L) (mm)	Width (W) (mm)	Thickness (T)	D	Termination Band (t)	
				Max. (mm)	Min. (mm)	Max. (mm)	Min. (mm)
CDR31	0805	2.00	1.25	1.3	.50	.70	.30
CDR32	1206	3.20	1.60	1.3	—	.70	.30
CDR33	1210	3.20	2.50	1.5	—	.70	.30
CDR34	1812	4.50	3.20	1.5	—	.70	.30
CDR35	1825	4.50	6.40	1.5	—	.70	.30

# MIL-PRF-55681/Chips



## Military Part Number Identification CDR31

### CDR31 to MIL-PRF-55681/7

Military Type Designation 1/	Capacitance in pF	Capacitance tolerance	Rated temperature and voltage-temperature limits	WVDC
<b>AVX Style 0805/CDR31 (BP)</b>				
CDR31BP1R0B---	1.0	B,C	BP	100
CDR31BP1R1B---	1.1	B,C	BP	100
CDR31BP1R2B---	1.2	B,C	BP	100
CDR31BP1R3B---	1.3	B,C	BP	100
CDR31BP1R5B---	1.5	B,C	BP	100
CDR31BP1R6B---	1.6	B,C	BP	100
CDR31BP1R8B---	1.8	B,C	BP	100
CDR31BP2R0B---	2.0	B,C	BP	100
CDR31BP2R2B---	2.2	B,C	BP	100
CDR31BP2R4B---	2.4	B,C	BP	100
CDR31BP2R7B---	2.7	B,C,D	BP	100
CDR31BP3R0B---	3.0	B,C,D	BP	100
CDR31BP3R3B---	3.3	B,C,D	BP	100
CDR31BP3R6B---	3.6	B,C,D	BP	100
CDR31BP3R9B---	3.9	B,C,D	BP	100
CDR31BP4R3B---	4.3	B,C,D	BP	100
CDR31BP4R7B---	4.7	B,C,D	BP	100
CDR31BP5R1B---	5.1	B,C,D	BP	100
CDR31BP5R6B---	5.6	B,C,D	BP	100
CDR31BP6R2B---	6.2	B,C,D	BP	100
CDR31BP6R8B---	6.8	B,C,D	BP	100
CDR31BP7R5B---	7.5	B,C,D	BP	100
CDR31BP8R2B---	8.2	B,C,D	BP	100
CDR31BP9R1B---	9.1	B,C,D	BP	100
CDR31BP100B---	10	F,J,K	BP	100
CDR31BP110B---	11	F,J,K	BP	100
CDR31BP120B---	12	F,J,K	BP	100
CDR31BP130B---	13	F,J,K	BP	100
CDR31BP150B---	15	F,J,K	BP	100
CDR31BP160B---	16	F,J,K	BP	100
CDR31BP180B---	18	F,J,K	BP	100
CDR31BP200B---	20	F,J,K	BP	100
CDR31BP220B---	22	F,J,K	BP	100
CDR31BP240B---	24	F,J,K	BP	100
CDR31BP270B---	27	F,J,K	BP	100
CDR31BP300B---	30	F,J,K	BP	100
CDR31BP330B---	33	F,J,K	BP	100
CDR31BP360B---	36	F,J,K	BP	100
CDR31BP390B---	39	F,J,K	BP	100
CDR31BP430B---	43	F,J,K	BP	100
CDR31BP470B---	47	F,J,K	BP	100
CDR31BP510B---	51	F,J,K	BP	100
CDR31BP560B---	56	F,J,K	BP	100
CDR31BP620B---	62	F,J,K	BP	100
CDR31BP680B---	68	F,J,K	BP	100
CDR31BP750B---	75	F,J,K	BP	100
CDR31BP820B---	82	F,J,K	BP	100
CDR31BP910B---	91	F,J,K	BP	100

- Add appropriate failure rate
- Add appropriate termination finish
- Capacitance Tolerance

Military Type Designation 1/	Capacitance in pF	Capacitance tolerance	Rated temperature and voltage-temperature limits	WVDC
<b>AVX Style 0805/CDR31 (BP) cont'd</b>				
CDR31BP101B---	100	F,J,K	BP	100
CDR31BP111B---	110	F,J,K	BP	100
CDR31BP121B---	120	F,J,K	BP	100
CDR31BP131B---	130	F,J,K	BP	100
CDR31BP151B---	150	F,J,K	BP	100
CDR31BP161B---	160	F,J,K	BP	100
CDR31BP181B---	180	F,J,K	BP	100
CDR31BP201B---	200	F,J,K	BP	100
CDR31BP221B---	220	F,J,K	BP	100
CDR31BP241B---	240	F,J,K	BP	100
CDR31BP271B---	270	F,J,K	BP	100
CDR31BP301B---	300	F,J,K	BP	100
CDR31BP331B---	330	F,J,K	BP	100
CDR31BP361B---	360	F,J,K	BP	100
CDR31BP391B---	390	F,J,K	BP	100
CDR31BP431B---	430	F,J,K	BP	100
CDR31BP471B---	470	F,J,K	BP	100
CDR31BP511A---	510	F,J,K	BP	50
CDR31BP561A---	560	F,J,K	BP	50
CDR31BP621A---	620	F,J,K	BP	50
CDR31BP681A---	680	F,J,K	BP	50
<b>AVX Style 0805/CDR31 (BX)</b>				
CDR31BX471B---	470	K,M	BX	100
CDR31BX561B---	560	K,M	BX	100
CDR31BX681B---	680	K,M	BX	100
CDR31BX821B---	820	K,M	BX	100
CDR31BX102B---	1,000	K,M	BX	100
CDR31BX122B---	1,200	K,M	BX	100
CDR31BX152B---	1,500	K,M	BX	100
CDR31BX182B---	1,800	K,M	BX	100
CDR31BX222B---	2,200	K,M	BX	100
CDR31BX272B---	2,700	K,M	BX	100
CDR31BX332B---	3,300	K,M	BX	100
CDR31BX392B---	3,900	K,M	BX	100
CDR31BX472B---	4,700	K,M	BX	100
CDR31BX562A---	5,600	K,M	BX	50
CDR31BX682A---	6,800	K,M	BX	50
CDR31BX822A---	8,200	K,M	BX	50
CDR31BX103A---	10,000	K,M	BX	50
CDR31BX123A---	12,000	K,M	BX	50
CDR31BX153A---	15,000	K,M	BX	50
CDR31BX183A---	18,000	K,M	BX	50

- Add appropriate failure rate
- Add appropriate termination finish
- Capacitance Tolerance

1/ The complete part number will include additional symbols to indicate capacitance tolerance, termination and failure rate level.

# MIL-PRF-55681/Chips



## Military Part Number Identification CDR32

### CDR32 to MIL-PRF-55681/8

Military Type Designation 1/	Capacitance in pF	Capacitance tolerance	Rated temperature and voltage-temperature limits	WVDC
<b>AVX Style 1206/CDR32 (BP)</b>				
CDR32BP1R0B---	1.0	B,C	BP	100
CDR32BP1R1B---	1.1	B,C	BP	100
CDR32BP1R2B---	1.2	B,C	BP	100
CDR32BP1R3B---	1.3	B,C	BP	100
CDR32BP1R5B---	1.5	B,C	BP	100
CDR32BP1R6B---	1.6	B,C	BP	100
CDR32BP1R8B---	1.8	B,C	BP	100
CDR32BP2R0B---	2.0	B,C	BP	100
CDR32BP2R2B---	2.2	B,C	BP	100
CDR32BP2R4B---	2.4	B,C	BP	100
CDR32BP2R7B---	2.7	B,C,D	BP	100
CDR32BP3R0B---	3.0	B,C,D	BP	100
CDR32BP3R3B---	3.3	B,C,D	BP	100
CDR32BP3R6B---	3.6	B,C,D	BP	100
CDR32BP3R9B---	3.9	B,C,D	BP	100
CDR32BP4R3B---	4.3	B,C,D	BP	100
CDR32BP4R7B---	4.7	B,C,D	BP	100
CDR32BP5R1B---	5.1	B,C,D	BP	100
CDR32BP5R6B---	5.6	B,C,D	BP	100
CDR32BP6R2B---	6.2	B,C,D	BP	100
CDR32BP6R8B---	6.8	B,C,D	BP	100
CDR32BP7R5B---	7.5	B,C,D	BP	100
CDR32BP8R2B---	8.2	B,C,D	BP	100
CDR32BP9R1B---	9.1	B,C,D	BP	100
CDR32BP100B---	10	F,J,K	BP	100
CDR32BP110B---	11	F,J,K	BP	100
CDR32BP120B---	12	F,J,K	BP	100
CDR32BP130B---	13	F,J,K	BP	100
CDR32BP150B---	15	F,J,K	BP	100
CDR32BP160B---	16	F,J,K	BP	100
CDR32BP180B---	18	F,J,K	BP	100
CDR32BP200B---	20	F,J,K	BP	100
CDR32BP220B---	22	F,J,K	BP	100
CDR32BP240B---	24	F,J,K	BP	100
CDR32BP270B---	27	F,J,K	BP	100
CDR32BP300B---	30	F,J,K	BP	100
CDR32BP330B---	33	F,J,K	BP	100
CDR32BP360B---	36	F,J,K	BP	100
CDR32BP390B---	39	F,J,K	BP	100
CDR32BP430B---	43	F,J,K	BP	100
CDR32BP470B---	47	F,J,K	BP	100
CDR32BP510B---	51	F,J,K	BP	100
CDR32BP560B---	56	F,J,K	BP	100
CDR32BP620B---	62	F,J,K	BP	100
CDR32BP680B---	68	F,J,K	BP	100
CDR32BP750B---	75	F,J,K	BP	100
CDR32BP820B---	82	F,J,K	BP	100
CDR32BP910B---	91	F,J,K	BP	100

- Add appropriate failure rate
- Add appropriate termination finish
- Capacitance Tolerance

Military Type Designation 1/	Capacitance in pF	Capacitance tolerance	Rated temperature and voltage-temperature limits	WVDC
<b>AVX Style 1206/CDR32 (BP) cont'd</b>				
CDR32BP101B---	100	F,J,K	BP	100
CDR32BP111B---	110	F,J,K	BP	100
CDR32BP121B---	120	F,J,K	BP	100
CDR32BP131B---	130	F,J,K	BP	100
CDR32BP151B---	150	F,J,K	BP	100
CDR32BP161B---	160	F,J,K	BP	100
CDR32BP181B---	180	F,J,K	BP	100
CDR32BP201B---	200	F,J,K	BP	100
CDR32BP221B---	220	F,J,K	BP	100
CDR32BP241B---	240	F,J,K	BP	100
CDR32BP271B---	270	F,J,K	BP	100
CDR32BP301B---	300	F,J,K	BP	100
CDR32BP331B---	330	F,J,K	BP	100
CDR32BP361B---	360	F,J,K	BP	100
CDR32BP391B---	390	F,J,K	BP	100
CDR32BP431B---	430	F,J,K	BP	100
CDR32BP471B---	470	F,J,K	BP	100
CDR32BP511B---	510	F,J,K	BP	100
CDR32BP561B---	560	F,J,K	BP	100
CDR32BP621B---	620	F,J,K	BP	100
CDR32BP681B---	680	F,J,K	BP	100
CDR32BP751B---	750	F,J,K	BP	100
CDR32BP821B---	820	F,J,K	BP	100
CDR32BP911B---	910	F,J,K	BP	100
CDR32BP102B---	1,000	F,J,K	BP	100
CDR32BP112A---	1,100	F,J,K	BP	50
CDR32BP122A---	1,200	F,J,K	BP	50
CDR32BP132A---	1,300	F,J,K	BP	50
CDR32BP152A---	1,500	F,J,K	BP	50
CDR32BP162A---	1,600	F,J,K	BP	50
CDR32BP182A---	1,800	F,J,K	BP	50
CDR32BP202A---	2,000	F,J,K	BP	50
CDR32BP222A---	2,200	F,J,K	BP	50
<b>AVX Style 1206/CDR32 (BX)</b>				
CDR32BX472B---	4,700	K,M	BX	100
CDR32BX562B---	5,600	K,M	BX	100
CDR32BX682B---	6,800	K,M	BX	100
CDR32BX822B---	8,200	K,M	BX	100
CDR32BX103B---	10,000	K,M	BX	100
CDR32BX123B---	12,000	K,M	BX	100
CDR32BX153B---	15,000	K,M	BX	100
CDR32BX183A---	18,000	K,M	BX	50
CDR32BX223A---	22,000	K,M	BX	50
CDR32BX273A---	27,000	K,M	BX	50
CDR32BX333A---	33,000	K,M	BX	50
CDR32BX393A---	39,000	K,M	BX	50

- Add appropriate failure rate
- Add appropriate termination finish
- Capacitance Tolerance

1/ The complete part number will include additional symbols to indicate capacitance tolerance, termination and failure rate level.



# MIL-PRF-55681/Chips



## Military Part Number Identification CDR33/34/35

### CDR33/34/35 to MIL-PRF-55681/9/10/11

Military Type Designation 1/	Capacitance in pF	Capacitance tolerance	Rated temperature and voltage-temperature limits	WVDC
<b>AVX Style 1210/CDR33 (BP)</b>				
CDR33BP102B---	1,000	F,J,K	BP	100
CDR33BP112B---	1,100	F,J,K	BP	100
CDR33BP122B---	1,200	F,J,K	BP	100
CDR33BP132B---	1,300	F,J,K	BP	100
CDR33BP152B---	1,500	F,J,K	BP	100
CDR33BP162B---	1,600	F,J,K	BP	100
CDR33BP182B---	1,800	F,J,K	BP	100
CDR33BP202B---	2,000	F,J,K	BP	100
CDR33BP222B---	2,200	F,J,K	BP	100
CDR33BP242A---	2,400	F,J,K	BP	50
CDR33BP272A---	2,700	F,J,K	BP	50
CDR33BP302A---	3,000	F,J,K	BP	50
CDR33BP332A---	3,300	F,J,K	BP	50
<b>AVX Style 1210/CDR33 (BX)</b>				
CDR33BX153B---	15,000	K,M	BX	100
CDR33BX183B---	18,000	K,M	BX	100
CDR33BX223B---	22,000	K,M	BX	100
CDR33BX273B---	27,000	K,M	BX	100
CDR33BX393A---	39,000	K,M	BX	50
CDR33BX473A---	47,000	K,M	BX	50
CDR33BX563A---	56,000	K,M	BX	50
CDR33BX683A---	68,000	K,M	BX	50
CDR33BX823A---	82,000	K,M	BX	50
CDR33BX104A---	100,000	K,M	BX	50
<b>AVX Style 1812/CDR34 (BP)</b>				
CDR34BP222B---	2,200	F,J,K	BP	100
CDR34BP242B---	2,400	F,J,K	BP	100
CDR34BP272B---	2,700	F,J,K	BP	100
CDR34BP302B---	3,000	F,J,K	BP	100
CDR34BP332B---	3,300	F,J,K	BP	100
CDR34BP362B---	3,600	F,J,K	BP	100
CDR34BP392B---	3,900	F,J,K	BP	100
CDR34BP432B---	4,300	F,J,K	BP	100
CDR34BP472B---	4,700	F,J,K	BP	100
CDR34BP512A---	5,100	F,J,K	BP	50
CDR34BP562A---	5,600	F,J,K	BP	50
CDR34BP622A---	6,200	F,J,K	BP	50
CDR34BP682A---	6,800	F,J,K	BP	50
CDR34BP752A---	7,500	F,J,K	BP	50
CDR34BP822A---	8,200	F,J,K	BP	50
CDR34BP912A---	9,100	F,J,K	BP	50
CDR34BP103A---	10,000	F,J,K	BP	50

- Add appropriate failure rate
- Add appropriate termination finish
- Capacitance Tolerance

Military Type Designation 1/	Capacitance in pF	Capacitance tolerance	Rated temperature and voltage-temperature limits	WVDC
<b>AVX Style 1812/CDR34 (BX)</b>				
CDR34BX273B---	27,000	K,M	BX	100
CDR34BX333B---	33,000	K,M	BX	100
CDR34BX393B---	39,000	K,M	BX	100
CDR34BX473B---	47,000	K,M	BX	100
CDR34BX563B---	56,000	K,M	BX	100
CDR34BX104A---	100,000	K,M	BX	50
CDR34BX124A---	120,000	K,M	BX	50
CDR34BX154A---	150,000	K,M	BX	50
CDR34BX184A---	180,000	K,M	BX	50
<b>AVX Style 1825/CDR35 (BP)</b>				
CDR35BP472B---	4,700	F,J,K	BP	100
CDR35BP512B---	5,100	F,J,K	BP	100
CDR35BP562B---	5,600	F,J,K	BP	100
CDR35BP622B---	6,200	F,J,K	BP	100
CDR35BP682B---	6,800	F,J,K	BP	100
CDR35BP752B---	7,500	F,J,K	BP	100
CDR35BP822B---	8,200	F,J,K	BP	100
CDR35BP912B---	9,100	F,J,K	BP	100
CDR35BP103B---	10,000	F,J,K	BP	100
CDR35BP113A---	11,000	F,J,K	BP	50
CDR35BP123A---	12,000	F,J,K	BP	50
CDR35BP133A---	13,000	F,J,K	BP	50
CDR35BP153A---	15,000	F,J,K	BP	50
CDR35BP163A---	16,000	F,J,K	BP	50
CDR35BP183A---	18,000	F,J,K	BP	50
CDR35BP203A---	20,000	F,J,K	BP	50
CDR35BP223A---	22,000	F,J,K	BP	50
<b>AVX Style 1825/CDR35 (BX)</b>				
CDR35BX563B---	56,000	K,M	BX	100
CDR35BX683B---	68,000	K,M	BX	100
CDR35BX823B---	82,000	K,M	BX	100
CDR35BX104B---	100,000	K,M	BX	100
CDR35BX124B---	120,000	K,M	BX	100
CDR35BX154B---	150,000	K,M	BX	100
CDR35BX184A---	180,000	K,M	BX	50
CDR35BX224A---	220,000	K,M	BX	50
CDR35BX274A---	270,000	K,M	BX	50
CDR35BX334A---	330,000	K,M	BX	50
CDR35BX394A---	390,000	K,M	BX	50
CDR35BX474A---	470,000	K,M	BX	50

- Add appropriate failure rate
- Add appropriate termination finish
- Capacitance Tolerance

1/ The complete part number will include additional symbols to indicate capacitance tolerance, termination and failure rate level.

# Packaging of Chip Components



## Automatic Insertion Packaging

### TAPE & REEL QUANTITIES

All tape and reel specifications are in compliance with RS481.

	8mm	12mm	
Paper or Embossed Carrier	0612, 0508, 0805, 1206, 1210		
Embossed Only		1808	1812, 1825 2220, 2225
Paper Only	0201, 0306, 0402, 0603		
Qty. per Reel/7" Reel	2,000, 3,000 or 4,000, 10,000, 15,000 Contact factory for exact quantity	3,000	500, 1,000 Contact factory for exact quantity
Qty. per Reel/13" Reel	5,000, 10,000, 50,000 Contact factory for exact quantity	10,000	4,000

### REEL DIMENSIONS

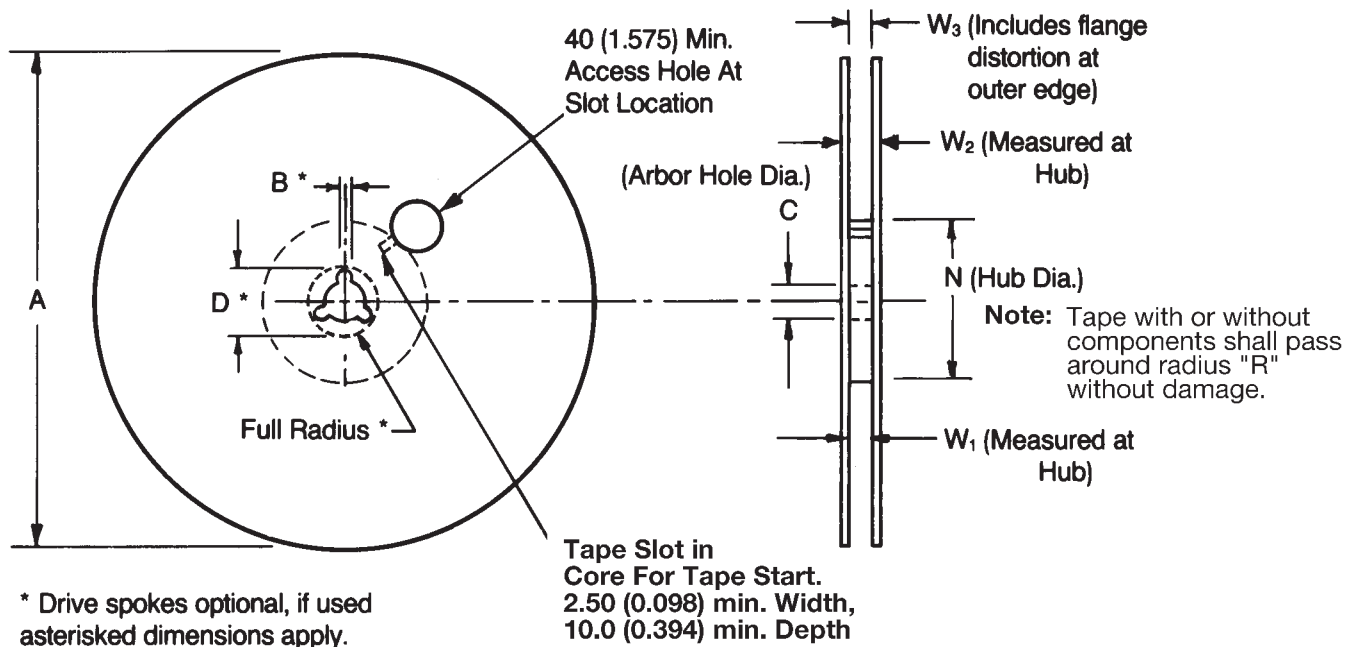

Tape Size <sup>(1)</sup>	A Max.	B* Min.	C	D* Min.	N Min.	W <sub>1</sub>	W <sub>2</sub> Max.	W <sub>3</sub>
8mm	330 (12.992)	1.5 (0.059)	13.0 <sup>+0.50</sup> <sub>-0.20</sub> (0.512 <sup>+0.020</sup> <sub>-0.008</sub> )	20.2 (0.795)	50.0 (1.969)	8.40 <sup>+1.5</sup> <sub>-0.6</sub> (0.331 <sup>+0.059</sup> <sub>-0.0</sub> )	14.4 (0.567)	7.90 Min. (0.311) 10.9 Max. (0.429)
12mm						12.4 <sup>+2.0</sup> <sub>-0.6</sub> (0.488 <sup>+0.079</sup> <sub>-0.0</sub> )	18.4 (0.724)	11.9 Min. (0.469) 15.4 Max. (0.607)

Metric dimensions will govern.

English measurements rounded and for reference only.

(1) For tape sizes 16mm and 24mm (used with chip size 3640) consult EIA RS-481 latest revision.

# Embossed Carrier Configuration



## 8 & 12mm Tape Only

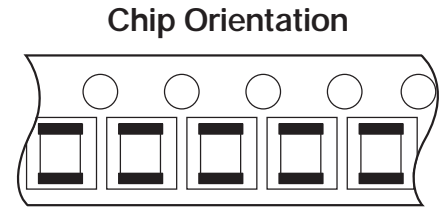
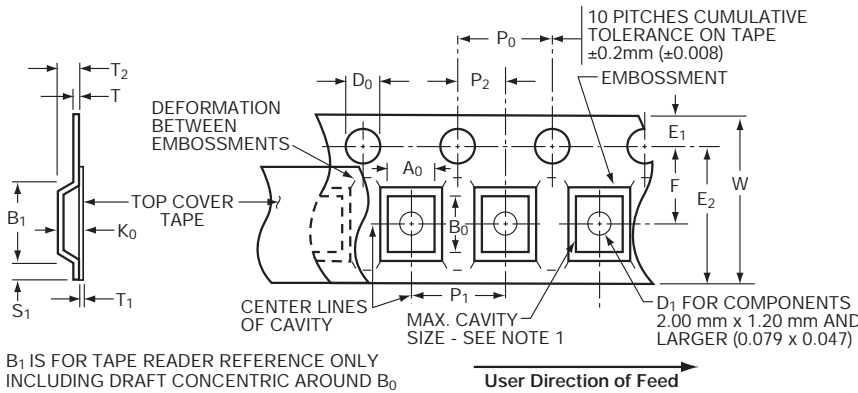

## 8 & 12mm Embossed Tape Metric Dimensions Will Govern

### CONSTANT DIMENSIONS

Tape Size	D <sub>0</sub>	E	P <sub>0</sub>	P <sub>2</sub>	S <sub>1</sub> Min.	T Max.	T <sub>1</sub>
8mm and 12mm	1.50 <sup>+0.10</sup> / <sub>0.0</sub> (0.059 <sup>+0.004</sup> / <sub>0.0</sub> )	1.75 ± 0.10 (0.069 ± 0.004)	4.0 ± 0.10 (0.157 ± 0.004)	2.0 ± 0.05 (0.079 ± 0.002)	0.60 (0.024)	0.60 (0.024)	0.10 (0.004) Max.

### VARIABLE DIMENSIONS

Tape Size	B <sub>1</sub> Max.	D <sub>1</sub> Min.	E <sub>2</sub> Min.	F	P <sub>1</sub> See Note 5	R Min. See Note 2	T <sub>2</sub>	W Max.	A <sub>0</sub> B <sub>0</sub> K <sub>0</sub>
8mm	4.35 (0.171)	1.00 (0.039)	6.25 (0.246)	3.50 ± 0.05 (0.138 ± 0.002)	4.00 ± 0.10 (0.157 ± 0.004)	25.0 (0.984)	2.50 Max. (0.098)	8.30 (0.327)	See Note 1
12mm	8.20 (0.323)	1.50 (0.059)	10.25 (0.404)	5.50 ± 0.05 (0.217 ± 0.002)	4.00 ± 0.10 (0.157 ± 0.004)	30.0 (1.181)	6.50 Max. (0.256)	12.3 (0.484)	See Note 1
8mm 1/2 Pitch	4.35 (0.171)	1.00 (0.039)	6.25 (0.246)	3.50 ± 0.05 (0.138 ± 0.002)	2.00 ± 0.10 (0.079 ± 0.004)	25.0 (0.984)	2.50 Max. (0.098)	8.30 (0.327)	See Note 1
12mm Double Pitch	8.20 (0.323)	1.50 (0.059)	10.25 (0.404)	5.50 ± 0.05 (0.217 ± 0.002)	8.00 ± 0.10 (0.315 ± 0.004)	30.0 (1.181)	6.50 Max. (0.256)	12.3 (0.484)	See Note 1

#### NOTES:

1. The cavity defined by A<sub>0</sub>, B<sub>0</sub>, and K<sub>0</sub> shall be configured to provide the following:

Surround the component with sufficient clearance such that:

- the component does not protrude beyond the sealing plane of the cover tape.
- the component can be removed from the cavity in a vertical direction without mechanical restriction, after the cover tape has been removed.
- rotation of the component is limited to 20° maximum (see Sketches D & E).
- lateral movement of the component is restricted to 0.5mm maximum (see Sketch F).

2. Tape with or without components shall pass around radius "R" without damage.

3. Bar code labeling (if required) shall be on the side of the reel opposite the round sprocket holes. Refer to EIA-556.

4. B<sub>1</sub> dimension is a reference dimension for tape feeder clearance only.

5. If P<sub>1</sub> = 2.0mm, the tape may not properly index in all tape feeders.

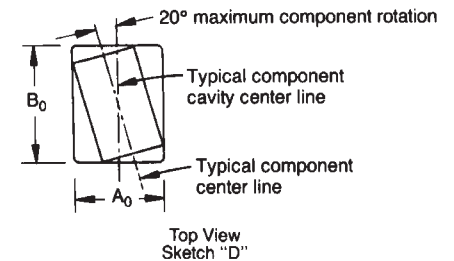
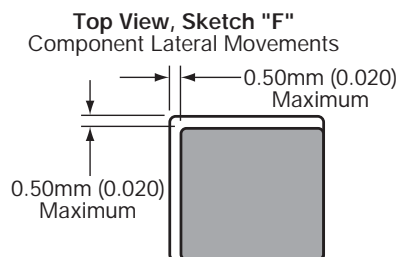
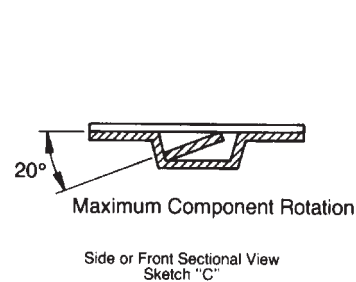

# Paper Carrier Configuration

8 & 12mm Tape Only

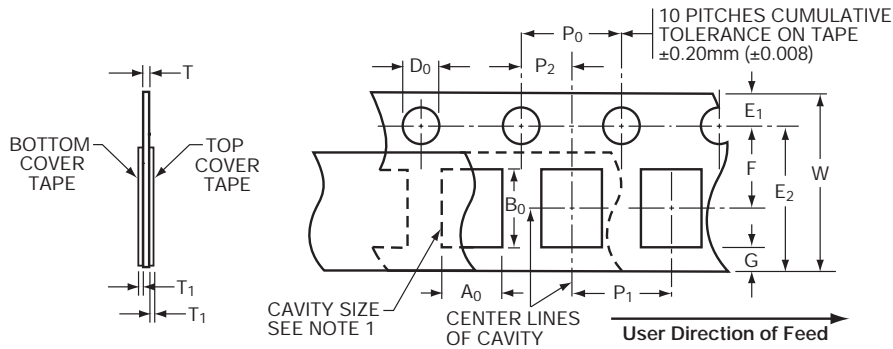

## 8 & 12mm Paper Tape Metric Dimensions Will Govern

### CONSTANT DIMENSIONS

Tape Size	D <sub>0</sub>	E	P <sub>0</sub>	P <sub>2</sub>	T <sub>1</sub>	G. Min.	R Min.
8mm and 12mm	1.50 <sup>+0.10</sup> <sub>-0.004</sub> (0.059 <sup>+0.004</sup> <sub>-0.004</sub> )	1.75 ± 0.10 (0.069 ± 0.004)	4.00 ± 0.10 (0.157 ± 0.004)	2.00 ± 0.05 (0.079 ± 0.002)	0.10 (0.004) Max.	0.75 (0.030) Min.	25.0 (0.984) See Note 2 Min.

### VARIABLE DIMENSIONS

Tape Size	P <sub>1</sub> See Note 4	E <sub>2</sub> Min.	F	W	A <sub>0</sub> B <sub>0</sub>	T
8mm	4.00 ± 0.10 (0.157 ± 0.004)	6.25 (0.246)	3.50 ± 0.05 (0.138 ± 0.002)	8.00 <sup>+0.30</sup> <sub>-0.10</sub> (0.315 <sup>+0.012</sup> <sub>-0.004</sub> )	See Note 1	1.10mm (0.043) Max. for Paper Base Tape and  1.60mm (0.063) Max. for Non-Paper Base Compositions
12mm	4.00 ± 0.010 (0.157 ± 0.004)	10.25 (0.404)	5.50 ± 0.05 (0.217 ± 0.002)	12.0 ± 0.30 (0.472 ± 0.012)		
8mm 1/2 Pitch	2.00 ± 0.05 (0.079 ± 0.002)	6.25 (0.246)	3.50 ± 0.05 (0.138 ± 0.002)	8.00 <sup>+0.30</sup> <sub>-0.10</sub> (0.315 <sup>+0.012</sup> <sub>-0.004</sub> )		
12mm Double Pitch	8.00 ± 0.10 (0.315 ± 0.004)	10.25 (0.404)	5.50 ± 0.05 (0.217 ± 0.002)	12.0 ± 0.30 (0.472 ± 0.012)		

**NOTES:**

- The cavity defined by A<sub>0</sub>, B<sub>0</sub>, and T shall be configured to provide sufficient clearance surrounding the component so that:
  - the component does not protrude beyond either surface of the carrier tape;
  - the component can be removed from the cavity in a vertical direction without mechanical restriction after the top cover tape has been removed;
  - rotation of the component is limited to 20° maximum (see Sketches A & B);
  - lateral movement of the component is restricted to 0.5mm maximum (see Sketch C).
- Tape with or without components shall pass around radius "R" without damage.
- Bar code labeling (if required) shall be on the side of the reel opposite the sprocket holes. Refer to EIA-556.
- If P<sub>1</sub> = 2.0mm, the tape may not properly index in all tape feeders.

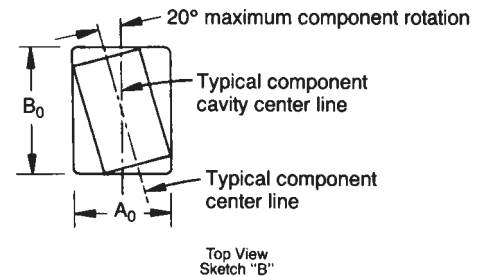
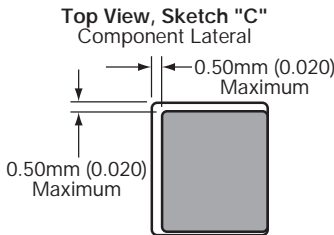
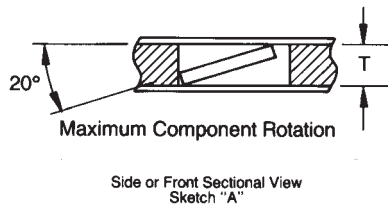

## Bar Code Labeling Standard

AVX bar code labeling is available and follows latest version of EIA-556



## BENEFITS

- Easier handling
- Smaller packaging volume  
(1/20 of T/R packaging)
- Easier inventory control
- Flexibility
- Recyclable

## CASE DIMENSIONS

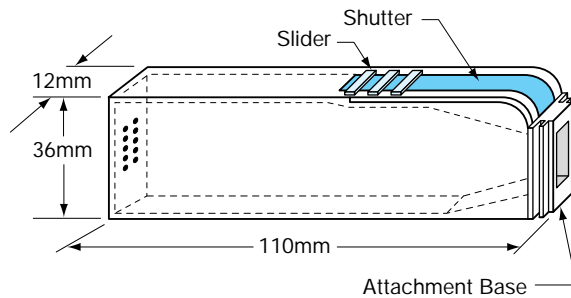

## BULK FEEDER

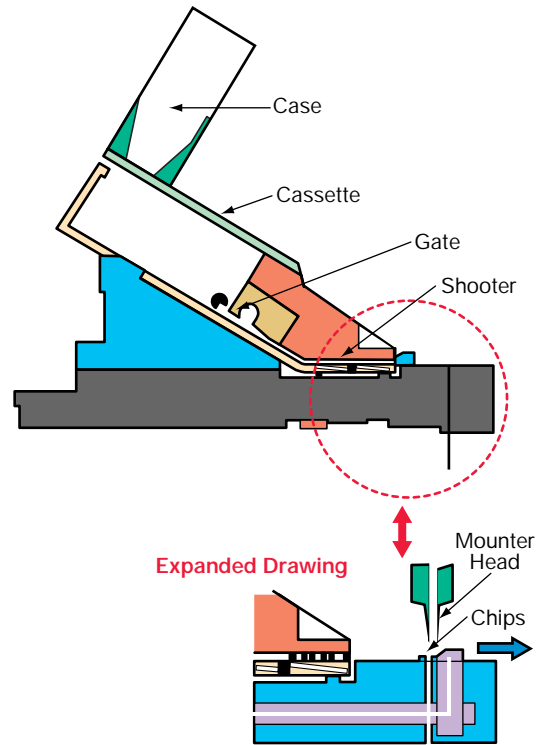

## CASE QUANTITIES

Part Size	0402	0603	0805	1206
Qty. (pcs / cassette)	80,000	15,000	10,000 (T=.023") 8,000 (T=.031") 6,000 (T=.043")	5,000 (T=.023") 4,000 (T=.032") 3,000 (T=.044")



## I. Capacitance (farads)

English:  $C = \frac{.224 \text{ K A}}{T_D}$

Metric:  $C = \frac{.0884 \text{ K A}}{T_D}$

## II. Energy stored in capacitors (Joules, watt - sec)

$$E = \frac{1}{2} CV^2$$

## III. Linear charge of a capacitor (Amperes)

$$I = C \frac{dV}{dt}$$

## IV. Total Impedance of a capacitor (ohms)

$$Z = \sqrt{R_s^2 + (X_C - X_L)^2}$$

## V. Capacitive Reactance (ohms)

$$X_C = \frac{1}{2 \pi fC}$$

## VI. Inductive Reactance (ohms)

$$X_L = 2 \pi fL$$

## VII. Phase Angles:

Ideal Capacitors: Current leads voltage 90°

Ideal Inductors: Current lags voltage 90°

Ideal Resistors: Current in phase with voltage

## VIII. Dissipation Factor (%)

$$D.F. = \tan \delta \text{ (loss angle)} = \frac{E.S.R.}{X_C} = (2 \pi fC) (E.S.R.)$$

## IX. Power Factor (%)

P.F. = Sine  $\delta$  (loss angle) = Cos  $\phi$  (phase angle)

P.F. = (when less than 10%) = DF

## X. Quality Factor (dimensionless)

$$Q = \text{Cotan } \delta \text{ (loss angle)} = \frac{1}{D.F.}$$

## XI. Equivalent Series Resistance (ohms)

$$E.S.R. = (D.F.) (X_C) = (D.F.) / (2 \pi fC)$$

## XII. Power Loss (watts)

$$\text{Power Loss} = (2 \pi fCV^2) (D.F.)$$

## XIII. KVA (Kilowatts)

$$KVA = 2 \pi fCV^2 \times 10^{-3}$$

## XIV. Temperature Characteristic (ppm/°C)

$$T.C. = \frac{C_t - C_{25}}{C_{25} (T_t - 25)} \times 10^6$$

## XV. Cap Drift (%)

$$C.D. = \frac{C_1 - C_2}{C_1} \times 100$$

## XVI. Reliability of Ceramic Capacitors

$$\frac{L_0}{L_t} = \left( \frac{V_t}{V_0} \right)^X \left( \frac{T_t}{T_0} \right)^Y$$

## XVII. Capacitors in Series (current the same)

$$\text{Any Number: } \frac{1}{C_T} = \frac{1}{C_1} + \frac{1}{C_2} \dots \frac{1}{C_N}$$

$$\text{Two: } C_T = \frac{C_1 C_2}{C_1 + C_2}$$

## XVIII. Capacitors in Parallel (voltage the same)

$$C_T = C_1 + C_2 \dots + C_N$$

## XIX. Aging Rate

A.R. = % $\Delta$  C/decade of time

## XX. Decibels

$$db = 20 \log \frac{V_1}{V_2}$$

## METRIC PREFIXES

## SYMBOLS

Pico	X 10 <sup>-12</sup>
Nano	X 10 <sup>-9</sup>
Micro	X 10 <sup>-6</sup>
Milli	X 10 <sup>-3</sup>
Deci	X 10 <sup>-1</sup>
Deca	X 10 <sup>+1</sup>
Kilo	X 10 <sup>+3</sup>
Mega	X 10 <sup>+6</sup>
Giga	X 10 <sup>+9</sup>
Tera	X 10 <sup>+12</sup>

K = Dielectric Constant	f = frequency	L <sub>t</sub> = Test life
A = Area	L = Inductance	V <sub>t</sub> = Test voltage
T <sub>D</sub> = Dielectric thickness	$\delta$ = Loss angle	V <sub>o</sub> = Operating voltage
V = Voltage	$\phi$ = Phase angle	T <sub>t</sub> = Test temperature
t = time	X & Y = exponent effect of voltage and temp.	T <sub>o</sub> = Operating temperature
R <sub>S</sub> = Series Resistance	L <sub>o</sub> = Operating life	

**Basic Construction** – A multilayer ceramic (MLC) capacitor is a monolithic block of ceramic containing two sets of offset, interleaved planar electrodes that extend to two opposite surfaces of the ceramic dielectric. This simple

structure requires a considerable amount of sophistication, both in material and manufacture, to produce it in the quality and quantities needed in today's electronic equipment.

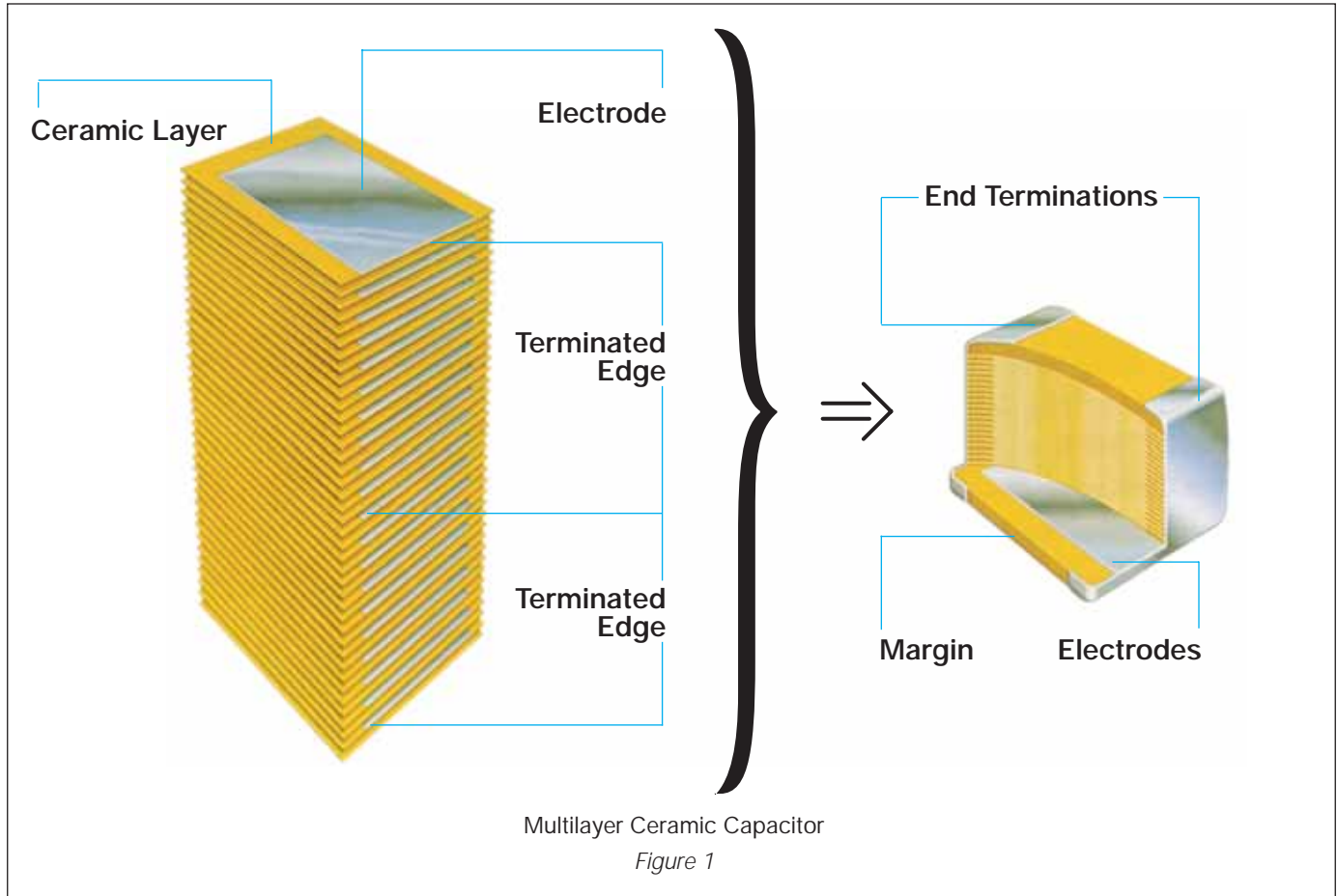

**Formulations** – Multilayer ceramic capacitors are available in both Class 1 and Class 2 formulations. Temperature compensating formulations are Class 1 and temperature stable and general application formulations are classified as Class 2.

**Class 1** – Class 1 capacitors or temperature compensating capacitors are usually made from mixtures of titanates where barium titanate is normally not a major part of the mix. They have predictable temperature coefficients and in general, do not have an aging characteristic. Thus they are the most stable capacitor available. The most popular Class 1 multilayer ceramic capacitors are COG (NP0) temperature compensating capacitors (negative-positive 0 ppm/°C).

**Class 2** – EIA Class 2 capacitors typically are based on the chemistry of barium titanate and provide a wide range of capacitance values and temperature stability. The most commonly used Class 2 dielectrics are X7R and Y5V. The X7R provides intermediate capacitance values which vary only  $\pm 15\%$  over the temperature range of  $-55^{\circ}\text{C}$  to  $125^{\circ}\text{C}$ . It finds applications where stability over a wide temperature range is required.

The Y5V provides the highest capacitance values and is used in applications where limited temperature changes are expected. The capacitance value for Y5V can vary from 22% to -82% over the  $-30^{\circ}\text{C}$  to  $85^{\circ}\text{C}$  temperature range.

All Class 2 capacitors vary in capacitance value under the influence of temperature, operating voltage (both AC and DC), and frequency. For additional information on performance changes with operating conditions, consult AVX's software, SpiCap.

**Table 1: EIA and MIL Temperature Stable and General Application Codes**

<i>EIA CODE</i>	
<i>Percent Capacity Change Over Temperature Range</i>	
<b>RS198</b>	<b>Temperature Range</b>
X7	-55°C to +125°C
X6	-55°C to +105°C
X5	-55°C to +85°C
Y5	-30°C to +85°C
Z5	+10°C to +85°C
<b>Code</b>	<b>Percent Capacity Change</b>
D	±3.3%
E	±4.7%
F	±7.5%
P	±10%
R	±15%
S	±22%
T	+22%, -33%
U	+22%, -56%
V	+22%, -82%

EXAMPLE – A capacitor is desired with the capacitance value at 25°C to increase no more than 7.5% or decrease no more than 7.5% from -30°C to +85°C. EIA Code will be Y5F.

<i>MIL CODE</i>		
<b>Symbol</b>	<b>Temperature Range</b>	
A	-55°C to +85°C	
B	-55°C to +125°C	
C	-55°C to +150°C	
<b>Symbol</b>	<b>Cap. Change Zero Volts</b>	<b>Cap. Change Rated Volts</b>
R	+15%, -15%	+15%, -40%
S	+22%, -22%	+22%, -56%
W	+22%, -56%	+22%, -66%
X	+15%, -15%	+15%, -25%
Y	+30%, -70%	+30%, -80%
Z	+20%, -20%	+20%, -30%

Temperature characteristic is specified by combining range and change symbols, for example BR or AW. Specification slash sheets indicate the characteristic applicable to a given style of capacitor.

In specifying capacitance change with temperature for Class 2 materials, EIA expresses the capacitance change over an operating temperature range by a 3 symbol code. The first symbol represents the cold temperature end of the temperature range, the second represents the upper limit of the operating temperature range and the third symbol represents the capacitance change allowed over the operating temperature range. Table 1 provides a detailed explanation of the EIA system.

**Effects of Voltage** – Variations in voltage have little effect on Class 1 dielectric but does affect the capacitance and dissipation factor of Class 2 dielectrics. The application of DC voltage reduces both the capacitance and dissipation factor while the application of an AC voltage within a reasonable range tends to increase both capacitance and dissipation factor readings. If a high enough AC voltage is applied, eventually it will reduce capacitance just as a DC voltage will. Figure 2 shows the effects of AC voltage.

**Cap. Change vs. A.C. Volts  
X7R**

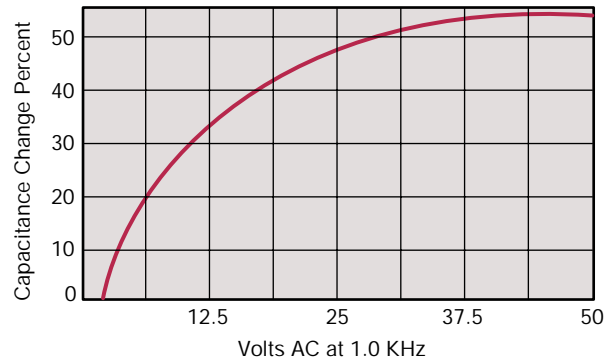

Figure 2

Capacitor specifications specify the AC voltage at which to measure (normally 0.5 or 1 VAC) and application of the wrong voltage can cause spurious readings. Figure 3 gives the voltage coefficient of dissipation factor for various AC voltages at 1 kilohertz. Applications of different frequencies will affect the percentage changes versus voltages.

**D.F. vs. A.C. Measurement Volts  
X7R**

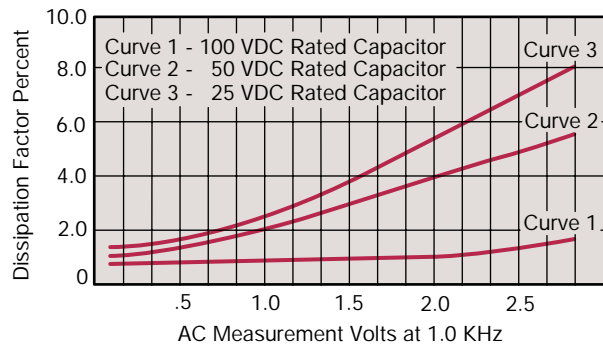

Figure 3

Typical effect of the application of DC voltage is shown in Figure 4. The voltage coefficient is more pronounced for higher K dielectrics. These figures are shown for room temperature conditions. The combination characteristic known as voltage temperature limits which shows the effects of rated voltage over the operating temperature range is shown in Figure 5 for the military BX characteristic.

**Typical Cap. Change vs. D.C. Volts  
X7R**

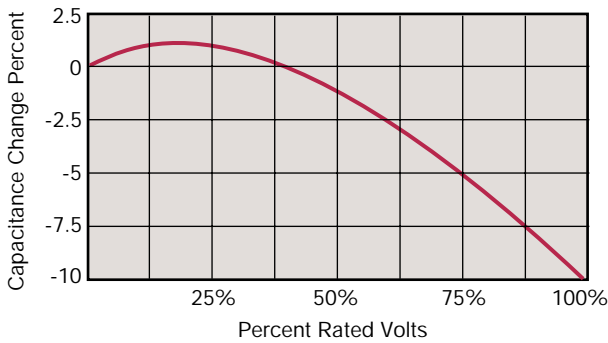

Figure 4

**Typical Cap. Change vs. Temperature  
X7R**

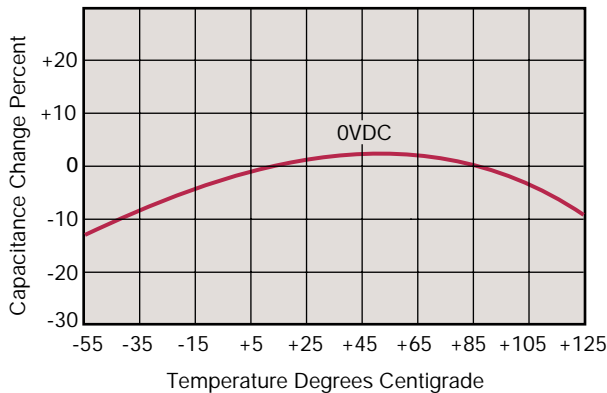

Figure 5

**Effects of Time** – Class 2 ceramic capacitors change capacitance and dissipation factor with time as well as temperature, voltage and frequency. This change with time is known as aging. Aging is caused by a gradual re-alignment of the crystalline structure of the ceramic and produces an exponential loss in capacitance and decrease in dissipation factor versus time. A typical curve of aging rate for semi-stable ceramics is shown in Figure 6.

If a Class 2 ceramic capacitor that has been sitting on the shelf for a period of time, is heated above its curie point, (125°C for 4 hours or 150°C for ½ hour will suffice) the part will de-age and return to its initial capacitance and dissipation factor readings. Because the capacitance changes rapidly, immediately after de-aging, the basic capacitance measurements are normally referred to a time period sometime after the de-aging process. Various manufacturers use different time bases but the most popular one is one day or twenty-four hours after “last heat.” Change in the aging curve can be caused by the application of voltage and other stresses. The possible changes in capacitance due to de-aging by heating the unit explain why capacitance changes are allowed after test, such as temperature cycling, moisture resistance, etc., in MIL specs. The application of high voltages such as dielectric withstanding voltages also

tends to de-age capacitors and is why re-reading of capacitance after 12 or 24 hours is allowed in military specifications after dielectric strength tests have been performed.

**Typical Curve of Aging Rate  
X7R**

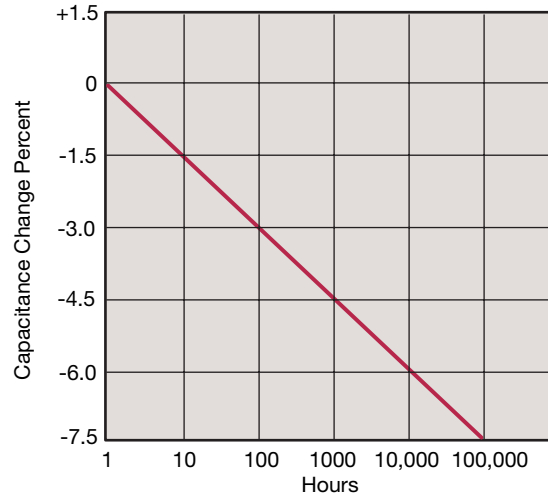

Characteristic	Max. Aging Rate %/Decade
C0G (NP0)	None
X7R, X5R	2
Y5V	7

Figure 6

**Effects of Frequency** – Frequency affects capacitance and impedance characteristics of capacitors. This effect is much more pronounced in high dielectric constant ceramic formulation than in low K formulations. AVX’s SpiCap software generates impedance, ESR, series inductance, series resonant frequency and capacitance all as functions of frequency, temperature and DC bias for standard chip sizes and styles. It is available free from AVX and can be downloaded for free from AVX website: [www.avx.com](http://www.avx.com).



**Effects of Mechanical Stress** – High “K” dielectric ceramic capacitors exhibit some low level piezoelectric reactions under mechanical stress. As a general statement, the piezoelectric output is higher, the higher the dielectric constant of the ceramic. It is desirable to investigate this effect before using high “K” dielectrics as coupling capacitors in extremely low level applications.

**Reliability** – Historically ceramic capacitors have been one of the most reliable types of capacitors in use today. The approximate formula for the reliability of a ceramic capacitor is:

$$\frac{L_o}{L_t} = \left(\frac{V_t}{V_o}\right)^X \left(\frac{T_t}{T_o}\right)^Y$$

where

$L_o$  = operating life                       $T_t$  = test temperature and  
 $L_t$  = test life                               $T_o$  = operating temperature  
 $V_t$  = test voltage                          in °C  
 $V_o$  = operating voltage               $X, Y$  = see text

Historically for ceramic capacitors exponent X has been considered as 3. The exponent Y for temperature effects typically tends to run about 8.

A capacitor is a component which is capable of storing electrical energy. It consists of two conductive plates (electrodes) separated by insulating material which is called the dielectric. A typical formula for determining capacitance is:

$$C = \frac{.224 KA}{t}$$

$C$  = capacitance (picofarads)  
 $K$  = dielectric constant (Vacuum = 1)  
 $A$  = area in square inches  
 $t$  = separation between the plates in inches  
 (thickness of dielectric)  
 $.224$  = conversion constant  
 (.0884 for metric system in cm)

**Capacitance** – The standard unit of capacitance is the farad. A capacitor has a capacitance of 1 farad when 1 coulomb charges it to 1 volt. One farad is a very large unit and most capacitors have values in the micro ( $10^{-6}$ ), nano ( $10^{-9}$ ) or pico ( $10^{-12}$ ) farad level.

**Dielectric Constant** – In the formula for capacitance given above the dielectric constant of a vacuum is arbitrarily chosen as the number 1. Dielectric constants of other materials are then compared to the dielectric constant of a vacuum.

**Dielectric Thickness** – Capacitance is indirectly proportional to the separation between electrodes. Lower voltage requirements mean thinner dielectrics and greater capacitance per volume.

**Area** – Capacitance is directly proportional to the area of the electrodes. Since the other variables in the equation are usually set by the performance desired, area is the easiest parameter to modify to obtain a specific capacitance within a material group.

**Energy Stored** – The energy which can be stored in a capacitor is given by the formula:

$$E = \frac{1}{2}CV^2$$

$E$  = energy in joules (watts-sec)  
 $V$  = applied voltage  
 $C$  = capacitance in farads

**Potential Change** – A capacitor is a reactive component which reacts against a change in potential across it. This is shown by the equation for the linear charge of a capacitor:

$$I_{ideal} = C \frac{dV}{dt}$$

where

$I$  = Current  
 $C$  = Capacitance  
 $dV/dt$  = Slope of voltage transition across capacitor

Thus an infinite current would be required to instantly change the potential across a capacitor. The amount of current a capacitor can “sink” is determined by the above equation.

**Equivalent Circuit** – A capacitor, as a practical device, exhibits not only capacitance but also resistance and inductance. A simplified schematic for the equivalent circuit is:

$C$  = Capacitance                               $L$  = Inductance  
 $R_s$  = Series Resistance                       $R_p$  = Parallel Resistance

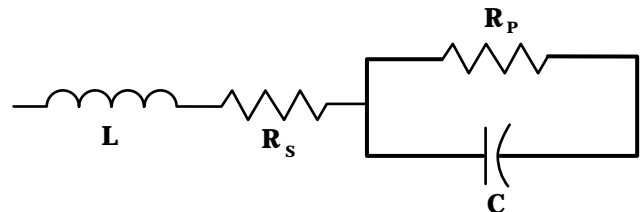

**Reactance** – Since the insulation resistance ( $R_p$ ) is normally very high, the total impedance of a capacitor is:

$$Z = \sqrt{R_s^2 + (X_c - X_L)^2}$$

where

$Z$  = Total Impedance  
 $R_s$  = Series Resistance  
 $X_c$  = Capacitive Reactance =  $\frac{1}{2\pi fC}$   
 $X_L$  = Inductive Reactance =  $2\pi fL$

The variation of a capacitor’s impedance with frequency determines its effectiveness in many applications.

**Phase Angle** – Power Factor and Dissipation Factor are often confused since they are both measures of the loss in a capacitor under AC application and are often almost identical in value. In a “perfect” capacitor the current in the capacitor will lead the voltage by 90°.

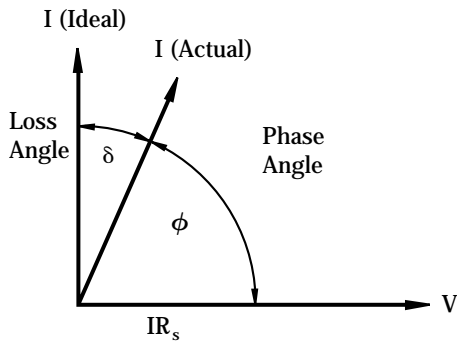

In practice the current leads the voltage by some other phase angle due to the series resistance  $R_s$ . The complement of this angle is called the loss angle and:

$$\text{Power Factor (P.F.)} = \cos \phi \text{ or } \sin \delta$$

$$\text{Dissipation Factor (D.F.)} = \tan \delta$$

for small values of  $\delta$  the tan and sine are essentially equal which has led to the common interchangeability of the two terms in the industry.

**Equivalent Series Resistance** – The term E.S.R. or Equivalent Series Resistance combines all losses both series and parallel in a capacitor at a given frequency so that the equivalent circuit is reduced to a simple R-C series connection.

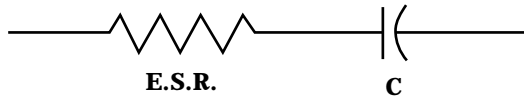

**Dissipation Factor** – The DF/PF of a capacitor tells what percent of the apparent power input will turn to heat in the capacitor.

$$\text{Dissipation Factor} = \frac{\text{E.S.R.}}{X_c} = (2 \pi fC) (\text{E.S.R.})$$

The watts loss are:

$$\text{Watts loss} = (2 \pi fCV^2) (\text{D.F.})$$

Very low values of dissipation factor are expressed as their reciprocal for convenience. These are called the “Q” or Quality factor of capacitors.

**Parasitic Inductance** – The parasitic inductance of capacitors is becoming more and more important in the decoupling of today’s high speed digital systems. The relationship between the inductance and the ripple voltage induced on the DC voltage line can be seen from the simple inductance equation:

$$V = L \frac{di}{dt}$$

The  $\frac{di}{dt}$  seen in current microprocessors can be as high as 0.3 A/ns, and up to 10A/ns. At 0.3 A/ns, 100pH of parasitic inductance can cause a voltage spike of 30mV. While this does not sound very drastic, with the  $V_{cc}$  for microprocessors decreasing at the current rate, this can be a fairly large percentage.

Another important, often overlooked, reason for knowing the parasitic inductance is the calculation of the resonant frequency. This can be important for high frequency, bypass capacitors, as the resonant point will give the most signal attenuation. The resonant frequency is calculated from the simple equation:

$$f_{res} = \frac{1}{2\pi\sqrt{LC}}$$

**Insulation Resistance** – Insulation Resistance is the resistance measured across the terminals of a capacitor and consists principally of the parallel resistance  $R_P$  shown in the equivalent circuit. As capacitance values and hence the area of dielectric increases, the I.R. decreases and hence the product ( $C \times IR$  or  $RC$ ) is often specified in ohm farads or more commonly megohm-microfarads. Leakage current is determined by dividing the rated voltage by IR (Ohm’s Law).

**Dielectric Strength** – Dielectric Strength is an expression of the ability of a material to withstand an electrical stress. Although dielectric strength is ordinarily expressed in volts, it is actually dependent on the thickness of the dielectric and thus is also more generically a function of volts/mil.

**Dielectric Absorption** – A capacitor does not discharge instantaneously upon application of a short circuit, but drains gradually after the capacitance proper has been discharged. It is common practice to measure the dielectric absorption by determining the “reappearing voltage” which appears across a capacitor at some point in time after it has been fully discharged under short circuit conditions.

**Corona** – Corona is the ionization of air or other vapors which causes them to conduct current. It is especially prevalent in high voltage units but can occur with low voltages as well where high voltage gradients occur. The energy discharged degrades the performance of the capacitor and can in time cause catastrophic failures.

### REFLOW SOLDERING

Case Size	D1	D2	D3	D4	D5
0402	1.70 (0.07)	0.60 (0.02)	0.50 (0.02)	0.60 (0.02)	0.50 (0.02)
0603	2.30 (0.09)	0.80 (0.03)	0.70 (0.03)	0.80 (0.03)	0.75 (0.03)
0805	3.00 (0.12)	1.00 (0.04)	1.00 (0.04)	1.00 (0.04)	1.25 (0.05)
1206	4.00 (0.16)	1.00 (0.04)	2.00 (0.09)	1.00 (0.04)	1.60 (0.06)
1210	4.00 (0.16)	1.00 (0.04)	2.00 (0.09)	1.00 (0.04)	2.50 (0.10)
1808	5.60 (0.22)	1.00 (0.04)	3.60 (0.14)	1.00 (0.04)	2.00 (0.08)
1812	5.60 (0.22)	1.00 (0.04)	3.60 (0.14)	1.00 (0.04)	3.00 (0.12)
1825	5.60 (0.22)	1.00 (0.04)	3.60 (0.14)	1.00 (0.04)	6.35 (0.25)
2220	6.60 (0.26)	1.00 (0.04)	4.60 (0.18)	1.00 (0.04)	5.00 (0.20)
2225	6.60 (0.26)	1.00 (0.04)	4.60 (0.18)	1.00 (0.04)	6.35 (0.25)

Dimensions in millimeters (inches)

#### Component Pad Design

Component pads should be designed to achieve good solder fillets and minimize component movement during reflow soldering. Pad designs are given below for the most common sizes of multilayer ceramic capacitors for both wave and reflow soldering. The basis of these designs is:

- Pad width equal to component width. It is permissible to decrease this to as low as 85% of component width but it is not advisable to go below this.
- Pad overlap 0.5mm beneath component.
- Pad extension 0.5mm beyond components for reflow and 1.0mm for wave soldering.

### WAVE SOLDERING

Case Size	D1	D2	D3	D4	D5
0603	3.10 (0.12)	1.20 (0.05)	0.70 (0.03)	1.20 (0.05)	0.75 (0.03)
0805	4.00 (0.15)	1.50 (0.06)	1.00 (0.04)	1.50 (0.06)	1.25 (0.05)
1206	5.00 (0.19)	1.50 (0.06)	2.00 (0.09)	1.50 (0.06)	1.60 (0.06)

Dimensions in millimeters (inches)

#### Component Spacing

For wave soldering components, must be spaced sufficiently far apart to avoid bridging or shadowing (inability of solder to penetrate properly into small spaces). This is less important for reflow soldering but sufficient space must be allowed to enable rework should it be required.

#### Preheat & Soldering

The rate of preheat should not exceed 4°C/second to prevent thermal shock. A better maximum figure is about 2°C/second.

For capacitors size 1206 and below, with a maximum thickness of 1.25mm, it is generally permissible to allow a temperature differential from preheat to soldering of 150°C. In all other cases this differential should not exceed 100°C.

For further specific application or process advice, please consult AVX.

#### Cleaning

Care should be taken to ensure that the capacitors are thoroughly cleaned of flux residues especially the space beneath the capacitor. Such residues may otherwise become conductive and effectively offer a low resistance bypass to the capacitor.

Ultrasonic cleaning is permissible, the recommended conditions being 8 Watts/litre at 20-45 kHz, with a process cycle of 2 minutes vapor rinse, 2 minutes immersion in the ultrasonic solvent bath and finally 2 minutes vapor rinse.

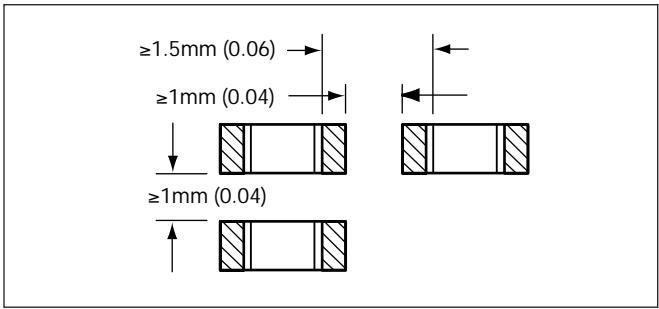

# Surface Mounting Guide



## MLC Chip Capacitors

### APPLICATION NOTES

#### Storage

Good solderability is maintained for at least twelve months, provided the components are stored in their "as received" packaging at less than 40°C and 70% RH.

#### Solderability

Terminations to be well soldered after immersion in a 60/40 tin/lead solder bath at  $235 \pm 5^\circ\text{C}$  for  $2 \pm 1$  seconds.

#### Leaching

Terminations will resist leaching for at least the immersion times and conditions shown below.

Termination Type	Solder Tin/Lead/Silver	Solder Temp. °C	Immersion Time Seconds
Nickel Barrier	60/40/0	$260 \pm 5$	$30 \pm 1$

### Recommended Soldering Profiles

#### Reflow

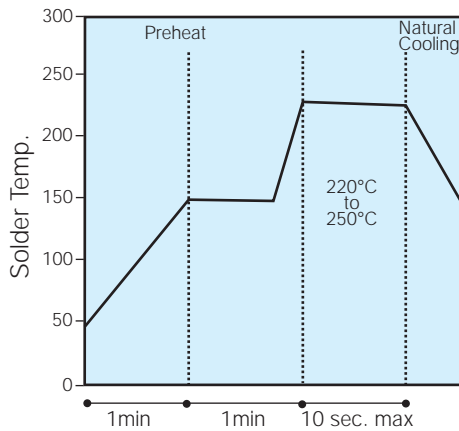

(Minimize soldering time)

#### Lead-Free Reflow Profile

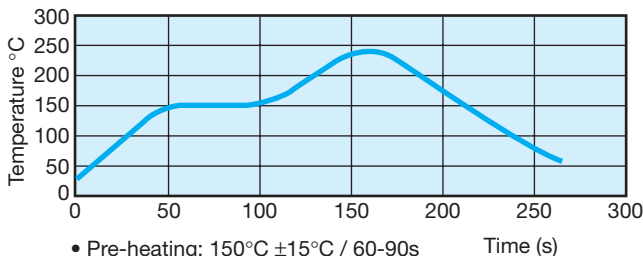

- Pre-heating:  $150^\circ\text{C} \pm 15^\circ\text{C} / 60\text{-}90\text{s}$
- Max. Peak Gradient  $2.5^\circ\text{C/s}$
- Peak Temperature:  $245^\circ\text{C} \pm 5^\circ\text{C}$
- Time at  $>230^\circ\text{C}$ : 40s Max.

#### Wave

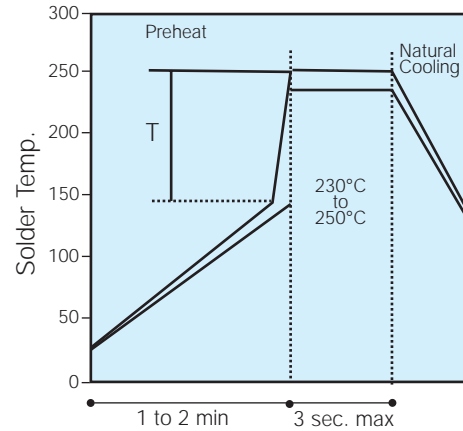

(Preheat chips before soldering)  
T/maximum  $150^\circ\text{C}$

#### Lead-Free Wave Soldering

The recommended peak temperature for lead-free wave soldering is  $250^\circ\text{C}$ - $260^\circ\text{C}$  for 3-5 seconds. The other parameters of the profile remains the same as above.

The following should be noted by customers changing from lead based systems to the new lead free pastes.

- The visual standards used for evaluation of solder joints will need to be modified as lead free joints are not as bright as with tin-lead pastes and the fillet may not be as large.
- Resin color may darken slightly due to the increase in temperature required for the new pastes.
- Lead-free solder pastes do not allow the same self alignment as lead containing systems. Standard mounting pads are acceptable, but machine set up may need to be modified.

#### General

Surface mounting chip multilayer ceramic capacitors are designed for soldering to printed circuit boards or other substrates. The construction of the components is such that they will withstand the time/temperature profiles used in both wave and reflow soldering methods.

#### Handling

Chip multilayer ceramic capacitors should be handled with care to avoid damage or contamination from perspiration and skin oils. The use of tweezers or vacuum pick ups is strongly recommended for individual components. Bulk handling should ensure that abrasion and mechanical shock are minimized. Taped and reeled components provides the ideal medium for direct presentation to the placement machine. Any mechanical shock should be minimized during handling chip multilayer ceramic capacitors.

#### Preheat

It is important to avoid the possibility of thermal shock during soldering and carefully controlled preheat is therefore required. The rate of preheat should not exceed  $4^\circ\text{C/second}$



## MLC Chip Capacitors

and a target figure 2°C/second is recommended. Although an 80°C to 120°C temperature differential is preferred, recent developments allow a temperature differential between the component surface and the soldering temperature of 150°C (Maximum) for capacitors of 1210 size and below with a maximum thickness of 1.25mm. The user is cautioned that the risk of thermal shock increases as chip size or temperature differential increases.

### Soldering

Mildly activated rosin fluxes are preferred. The minimum amount of solder to give a good joint should be used. Excessive solder can lead to damage from the stresses caused by the difference in coefficients of expansion between solder, chip and substrate. AVX terminations are suitable for all wave and reflow soldering systems. If hand soldering cannot be avoided, the preferred technique is the utilization of hot air soldering tools.

### Cooling

Natural cooling in air is preferred, as this minimizes stresses within the soldered joint. When forced air cooling is used, cooling rate should not exceed 4°C/second. Quenching is not recommended but if used, maximum temperature differentials should be observed according to the preheat conditions above.

### Cleaning

Flux residues may be hygroscopic or acidic and must be removed. AVX MLC capacitors are acceptable for use with all of the solvents described in the specifications MIL-STD-202 and EIA-RS-198. Alcohol based solvents are acceptable and properly controlled water cleaning systems are also acceptable. Many other solvents have been proven successful, and most solvents that are acceptable to other components on circuit assemblies are equally acceptable for use with ceramic capacitors.

## POST SOLDER HANDLING

Once SMP components are soldered to the board, any bending or flexure of the PCB applies stresses to the soldered joints of the components. For leaded devices, the stresses are absorbed by the compliancy of the metal leads and generally don't result in problems unless the stress is large enough to fracture the soldered connection.

Ceramic capacitors are more susceptible to such stress because they don't have compliant leads and are brittle in nature. The most frequent failure mode is low DC resistance or short circuit. The second failure mode is significant loss of capacitance due to severing of contact between sets of the internal electrodes.

Cracks caused by mechanical flexure are very easily identified and generally take one of the following two general forms:



Type A:  
Angled crack between bottom of device to top of solder joint.

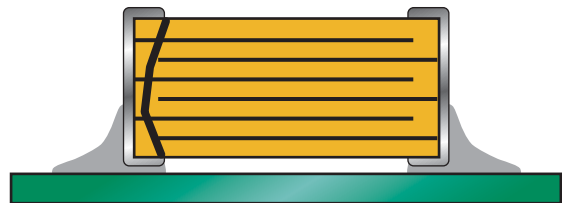

Type B:  
Fracture from top of device to bottom of device.

Mechanical cracks are often hidden underneath the termination and are difficult to see externally. However, if one end termination falls off during the removal process from PCB, this is one indication that the cause of failure was excessive mechanical stress due to board warping.

### COMMON CAUSES OF MECHANICAL CRACKING

The most common source for mechanical stress is board depanelization equipment, such as manual breakapart, v-cutters and shear presses. Improperly aligned or dull cutters may cause torqueing of the PCB resulting in flex stresses being transmitted to components near the board edge. Another common source of flexural stress is contact during parametric testing when test points are probed. If the PCB is allowed to flex during the test cycle, nearby ceramic capacitors may be broken.

A third common source is board to board connections at vertical connectors where cables or other PCBs are connected to the PCB. If the board is not supported during the plug/unplug cycle, it may flex and cause damage to nearby components.

Special care should also be taken when handling large (>6" on a side) PCBs since they more easily flex or warp than smaller boards.

### REWORKING OF MLCs

Thermal shock is common in MLCs that are manually attached or reworked with a soldering iron. *AVX strongly recommends that any reworking of MLCs be done with hot air reflow rather than soldering irons.* It is practically impossible to cause any thermal shock in ceramic capacitors when using hot air reflow.

However direct contact by the soldering iron tip often causes thermal cracks that may fail at a later date. If rework by soldering iron is absolutely necessary, it is recommended that the wattage of the iron be less than 30 watts and the tip temperature be <math><300^{\circ}\text{C}</math>. *Rework should be performed by applying the solder iron tip to the pad and not directly contacting any part of the ceramic capacitor.*

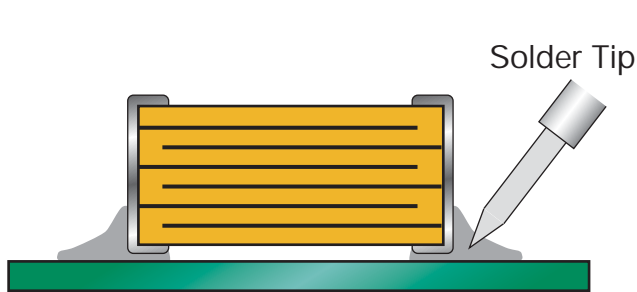

Preferred Method - No Direct Part Contact

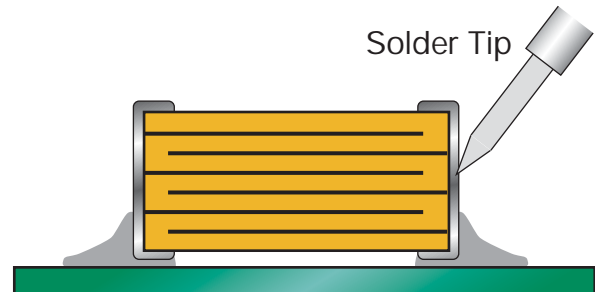

Poor Method - Direct Contact with Part

### PCB BOARD DESIGN

To avoid many of the handling problems, AVX recommends that MLCs be located at least .2" away from nearest edge of board. However when this is not possible, AVX recommends that the panel be routed along the cut line, adjacent to where the MLC is located.

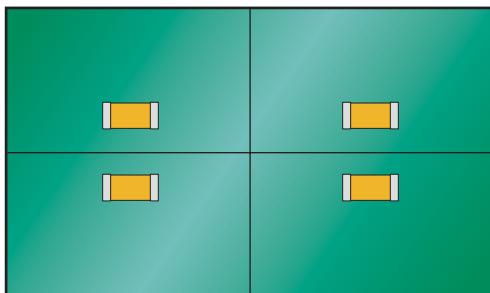

No Stress Relief for MLCs

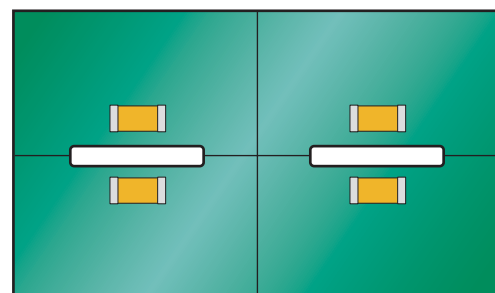

Routed Cut Line Relieves Stress on MLC

## USA

**AVX Myrtle Beach, SC**  
Corporate Offices  
Tel: 843-448-9411  
FAX: 843-448-1943

**AVX North Central, IN**  
Tel: 317-848-7153  
FAX: 317-844-9314

**AVX Southwest, AZ**  
Tel: 602-678-0384  
FAX: 602-678-0385

**AVX Southeast, GA**  
Tel: 404-608-8151  
FAX: 770-972-0766

**AVX Northwest, WA**  
Tel: 360-699-8746  
FAX: 360-699-8751

**AVX Mid/Pacific, CA**  
Tel: 510-661-4100  
FAX: 510-661-4101

**AVX South Central, TX**  
Tel: 972-669-1223  
FAX: 972-669-2090

**AVX Canada**  
Tel: 905-238-3151  
FAX: 905-238-0319

## EUROPE

**AVX Limited, England**  
European Headquarters  
Tel: ++44 (0) 1252-770000  
FAX: ++44 (0) 1252-770001

**AVX/ELCO, England**  
Tel: ++44 (0) 1638-675000  
FAX: ++44 (0) 1638-675002

**AVX S.A., France**  
Tel: ++33 (1) 69-18-46-00  
FAX: ++33 (1) 69-28-73-87

**AVX GmbH, Germany**  
Tel: ++49 (0) 8131-9004-0  
FAX: ++49 (0) 8131-9004-44

**AVX srl, Italy**  
Tel: ++390 (0)2 614-571  
FAX: ++390 (0)2 614-2576

**AVX Czech Republic**  
Tel: ++420 465-358-111  
FAX: ++420 465-323-010

## ASIA-PACIFIC

**AVX/Kyocera, Singapore**  
Asia-Pacific Headquarters  
Tel: (65) 6286-7555  
FAX: (65) 6488-9880

**AVX/Kyocera, Hong Kong**  
Tel: (852) 2-363-3303  
FAX: (852) 2-765-8185

**AVX/Kyocera, Korea**  
Tel: (82) 2-785-6504  
FAX: (82) 2-784-5411

**AVX/Kyocera, Taiwan**  
Tel: (886) 2-2698-8778  
FAX: (886) 2-2698-8777

**AVX/Kyocera, Malaysia**  
Tel: (60) 4-228-1190  
FAX: (60) 4-228-1196

**Elco, Japan**  
Tel: 045-943-2906/7  
FAX: 045-943-2910

**Kyocera, Japan - AVX**  
Tel: (81) 75-604-3426  
FAX: (81) 75-604-3425

**Kyocera, Japan - KDP**  
Tel: (81) 75-604-3424  
FAX: (81) 75-604-3425

**AVX/Kyocera, Shanghai, China**  
Tel: 86-21 6886 1000  
FAX: 86-21 6886 1010

**AVX/Kyocera, Tianjin, China**  
Tel: 86-22 2576 0098  
FAX: 86-22 2576 0096

**Contact:**

